

FEATURES

- 100 kHz max excitation output
- Impedance range 0.1 kΩ to 10 MΩ, 12-bit resolution
- Selectable system clock from the following:
 - RC oscillator, external clock
- DSP real and imaginary calculation (DFT)
- 3 V/5 V power supply
- Programmable sinewave output
- Frequency resolution 27 bits (<0.1 Hz)
- Frequency sweep capability with serial I²C loading
- 12-Bit sampling ADC
- ADC sampling 1 MSPS, INL ± 1 LSB max
- On-chip temp sensor allows ±2 °C accuracy
- Temperature range -40°C to +125°C
- 16 lead SSOP package

APPLICATIONS

- Complex impedance measurement
- Corrosion monitoring
- Impedance spectrometry
- Biomedical and automotive sensors
- Proximity sensors
- DFT processing

GENERAL DESCRIPTION

The AD5933 is a high precision impedance converter system solution which combines an on board frequency generator with a 12 Bit 1MSPS ADC. The frequency generator allows an external complex impedance to be excited with a known frequency. The response signal from the impedance is sampled by the on board ADC and DFT processed by an on-board DSP engine. The DFT algorithm returns a Real (R) and imaginary (I) data word at each output frequency. This magnitude of these data words must be further scaled by calibrated Gain Factor in order to return the actual impedance value at each frequency

point. The magnitude of the impedance and relative phase of the impedance at each frequency point along the sweep is easily calculated using the following equations:

$$\text{Magnitude} = \sqrt{R^2 + I^2} \quad \text{Phase} = \text{Tan}^{-1}(I/R)$$

To determine the value of the unknown impedance Z(w), generally a frequency sweep is performed. The impedance can be calculated at each point and an impedance profile i.e. frequency vs. magnitude plot can be created. The system allows the user to program a 2 V p-p sinusoidal signal as excitation to an external load. Output voltage excitation ranges of 1 V, 400 mV, 200 mV can also be programmed. The signal is provided on chip using DDS techniques. Frequency resolution of 27 bits (less than 0.1HZ) can be achieved using this method. To perform the frequency sweep, the user must first program the conditions required for the sweep; start frequency, step frequency, and number of incremental points along the sweep into onboard registers. Once the relevant registers have been programmed, a Start Command to the control register is required in order to begin the sweep. To determine the impedance of the load at any one frequency point, Z(w), a measurement system comprised of a transimpedance amplifier, gain stage, and ADC are used to record data. The gain stage for the response stage is 1 or 5. At each point on the sweep the ADC will take 1024 samples and calculate a Discrete Fourier Transform to provide the real and imaginary data for the response signal waveform. The real and imaginary data stored in memory and is available to the user through the I²C interface. The ADC is a low noise; high speed 1 MSPS sampling ADC that operates from 3 V supply. Clocking for both the DDS and ADC signals is provided externally via the MCLK reference clock, which is provided externally from a crystal oscillator or system clock or by use of the internal RC oscillator. The AD5933 is available in a 16 lead SSOP.

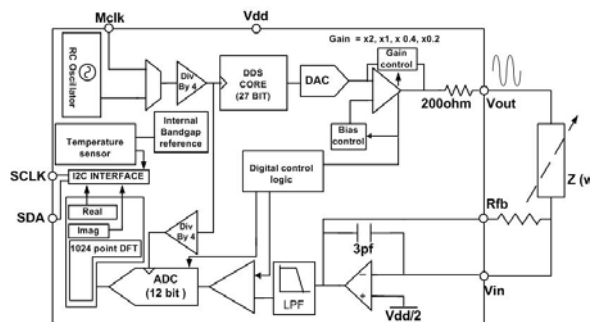

Figure 1. AD5933 Block Diagram

Rev. PrB

Information furnished by Analog Devices is believed to be accurate and reliable. However, no responsibility is assumed by Analog Devices for its use, nor for any infringements of patents or other rights of third parties that may result from its use. Specifications subject to change without notice. No license is granted by implication or otherwise under any patent or patent rights of Analog Devices. Trademarks and registered trademarks are the property of their respective owners.

TABLE OF CONTENTS

Specifications.....	3	Analog Channel and Filter Network.....	25
Timing Characteristics.....	9	The Analog-to-Digital Converter	25
Absolute Maximum Ratings.....	10	The Discrete Fourier Transform	25
ESD Caution.....	10	AD5933 Discrete Fourier Transform Leakage	26
Pin Configuration and Descriptions.....	11	Gain Factor Calculation	28
Typical Performance Characteristics	12	AD5933 System Calibration	29
Terminology	17	Performing a Frequency Sweep—Flow Chart	32
DAC/DDS core:	17	Register Map (Each Row Equals 8 Bits of Data)	33
ADC:	18	Control Register	37
System Architecture Description.....	19	Control Register Decode	38
Output Stage.....	19	Status Register:.....	39
DDS Core: Circuit Description	19	Serial Bus Interface.....	40
Numerical Controlled Oscillator.....	20	General I ² C Timing.....	40
SIN ROM	20	Writing/Reading to the AD5933	41
Digital-to-Analog Converter & Output Gain Stage.....	20	Block Write.....	43
Response Stage.....	20	AD5933 Read Operations	44
ADC Operation	21	Error Correction.....	45
DFT Conversion	21	Checksum.....	45
Temperature Sensor	22	User Command Codes	45
AD5933 Theory of Operation.....	24	Writing to Memory: Storing Calibration Variables.	46
Oscillator Core.....	24	Outline Dimensions	49
DDS Core.....	24	Ordering Guide	49

REVISION HISTORY

3/05—Revision PrB

SPECIFICATIONS

$V_{DD} = +3.0\text{ V} \pm 10\%$ T_{MIN} to T_{MAX} unless otherwise noted.

Table 1.

Parameter	Y Version ^{1,2}			Unit	Test Conditions/Comments
	Min	Typ	Max		
SYSTEM SPECS					
Impedance Range	0.001		10	MΩ	
Total System Accuracy		1		%	
System ppm		250		ppm/°C	Vdd = 3.3 V @ 25°C, 500 Hz bandwidth
MCLK Update Rate			16	MSPS	System clock update rate
OUTPUT STAGE					
FREQUENCY SPECS					
Output Frequency Range	0		100 kHz	Hz	Uni-Polar Sinusoidal Signal at Vout. System accuracy only guaranteed in this range. >100 kHz achievable by device but accuracy not guaranteed.
Output Frequency Resoluion		27		Bits	<0.1 Hz Resolution achievable using DDS techniques
MCLK					External Reference Clock.
Initial Frequency Accuracy		0.1		Hz	System Output Excitation Frequency Accuracy using external clock/crystal post triml. 0-100 kHz Range.
RC OSCILLATOR					
Initial Frequency Accuracy	10	16.776	17.77	MHz	Internal RC Oscillator. Typically 16.776 MHz
		1.5		%	System Output Excitation Frequency Accuracy using internal clock oscillator post trim. 0-100 kHz Range.
Calibrated Frequency Accuracy		0.1		Hz	0-100 kHz Range. 1 point Offset Calibration
Frequency Tempco		35		ppm/°C	Requires 2 point User Calibration.
Frequency Jitter		4		Hz	Jitter on VOUT Pin, 30 kHz output.
OUTPUT VOLTAGE SPECS					
AC Voltage Range (div by 1)		2.0		Volts peak to peak	Pk-Pk Unipolar output excitation Voltage on VOut. Vdd = 3.3 V
Output Voltage Error		0.9		%	Voltage Error on Pk-Pk Output Excitation voltage. Vdd = 3.3 V
DC Bias (vdd/2)		1.65		Volts	DC bias of AC Signal vdd = 3.3 V
DC Bias Error		±9		%	Tolerance of DC Bias
AC Voltage Range div by 2		1.0		Volts peak to peak	Pk-Pk Unipolar output excitation Voltage on VOut. Vdd = 3.3 V
Output Voltage Error		0.8		%	Voltage Error on Pk-Pk Output excitation voltage. Vdd = 3.3 V
DC Bias (Vdd/4)		0.79		Volts	DC bias of AC Signal vdd = 3.3 V
DC Bias Error		±10		%	Tolerance of DC Bias
AC Voltage Range div by 5		0.4		Volts peak to peak	Pk-Pk Unipolar output excitation Voltage on VOut. Vdd = 3.3 V
Output Voltage Error		0.7		%	Voltage Error on Pk-Pk Output excitation voltage. Vdd = 3.3 V
DC Bias (Vdd/10)		0.32		Volts	DC bias of AC Signal vdd = 3.3 V
DC Bias Error		±9		%	Tolerance of DC Bias
AC Voltage Range div by 10		0.2		Volts peak to peak	Pk-Pk Unipolar output excitation Voltage on VOut. Vdd = 3.3 V
Output Voltage Error		0.4		%	Voltage Error on Pk-Pk Output excitation voltage. Vdd = 3.3 V
DC Bias (Vdd/20)		0.16		Volts	DC bias of AC Signal vdd = 3.3 V
DC Bias Error		±7		%	Tolerance of DC Bias

Parameter	Y Version ^{1,2}			Unit	Test Conditions/Comments
	Min	Typ	Max		
DC Output Impedance (at Vout)		400		Ω	2.0Vp-p, Output frequency = 30 kHz (external oscillator), vdd = 3.3 V, Ta = 25°C
DC Output Impedance		2.4		k Ω	1.0 Vp-p, Output frequency = 30 kHz (external oscillator), vdd = 3.3 V, Ta = 25°C
DC Output Impedance		1		k Ω	400 mVp-p, Output frequency = 30 kHz, (external oscillator) vdd = 3.3 V, Ta = 25°C
DC Output Impedance		600		Ω	200 mVp-p, Output frequency = 30 kHz (external oscillator), vdd = 3.3 V, Ta = 25°C
Short Circuit Current (at Vout)		± 7		mA	2.0 Vp-p, Output frequency = 30 kHz (external oscillator), vdd = 3.3 V, Ta = 25°C
Short Circuit Current		± 1		mA	2.0 Vp-p, Output frequency = 30 kHz (external oscillator), vdd = 3.3 V, Ta = 25°C
Short Circuit Current		± 2.5		mA	2.0 Vp-p, Output frequency = 30 kHz (external oscillator), vdd = 3.3 V, Ta = 25°C
Short Circuit Current		± 4.5		mA	2.0 Vp-p, Output frequency = 30 kHz (external oscillator), vdd = 3.3 V, Ta = 25°C
AC CHARACTERISTICS					
Signal to Noise Ratio		60		dB	Output excitation voltage = 30 kHz, external oscillator mclk = 16.776 MHz, Ta = 25°C vdd = 3.3 V
Total Harmonic Distortion		-52		dB	Output excitation voltage = 30kHz, external oscillator mclk = 16.776 MHz, Ta = 25°C vdd = 3.3 V
		-52		dB	Output excitation voltage = 30kHz, internal oscillator mclk = 16.776 MHz, Ta = 25°C vdd = 3.3 V
Spurious free Dynamic Range (SFDR) Wideband (0 to 1 MHz)		56		dB	Output excitation voltage = 30 kHz, external oscillator mclk = 16.776 MHz, Ta = 25°C vdd = 3.3 V
		56		dB	Output excitation voltage = 30kHz, internal oscillator mclk = 16.776 MHz, Ta = 25°C vdd = 3.3 V
Narrowband (± 5 kHz)		85		dB	Output excitation voltage = 30kHz, external oscillator mclk = 16.776 MHz, Ta = 25°C vdd = 3.3 V
		80		dB	Output excitation voltage = 30 kHz, internal oscillator mclk = 16.776 MHz, Ta = 25°C vdd = 3.3 V
Clock Feedthrough (0 to 17 MHz)		-60		dB	Output excitation voltage = 30 kHz, external oscillator mclk = 16.776 MHz, Ta = 25°C vdd = 3.3 V
SYSTEM RESPONSE STAGE					
ANALOG INPUT VIN					
Input Leakage Current		1		nA	To Pin VIN
Input Capacitance		3.5		pF	Pin capacitance between Vout and Gnd. Vdd = 3.3 V @25°C
Input Impedance		68.5G		Ω	Input impedance between Vout and Gnd. vdd = 3.3 V @25°C. No feedback resistor connected.
ADC ACCURACY					
Resolution		12		Bits	
Sampling Rate		1		MSPS	
Integral Nonlinearity		± 1		LSB	No missing Codes
Differential Nonlinearity		± 1		LSB	Guarentted monitonic

Parameter	Y Version ^{1,2}			Unit	Test Conditions/Comments
	Min	Typ	Max		
Offset Error		±3		LSB	
Gain Error		±6		LSB	
TEMPERATURE SENSOR					
Accuracy		±1		°C	Ta = -40°C to 125°C
Resolution		0.03125		°C	
Auto Conversion Update Rate		1		sec	Temperature measurement every 1 second
Temperature Conversion Time		800		µs	Vdd = 3.3 V
LOGIC INPUTS					
Vih, Input High Voltage	0.9		2.3	VDD = 3 V	
Vil, Input Low Voltage				VDD = 3 V	
Input Current			±4.2	µA	Vdd = 3.3 V, Ta = 25°C,
Input Capacitance			7	pF	Vdd = 3.3 V, Ta = 25°C
POWER REQUIREMENTS					
Vdd			3.3	Volts	
IDD (Normal Mode)		9		mA	Digital and analog supply currents
IDD (Powerdown Mode)		0.7		µA	Digital and analog supply currents

¹ Temperature ranges are as follows: Y version = -40°C to +125°C, typical at 25°C.

² Guaranteed by design and characterization, not production tested.

$V_{DD} = +5.0\text{ V} \pm 10\% T_{MIN}$ to T_{MAX} unless otherwise noted.

Table 2.

Parameter	Y Version ^{1,2}			Unit	Test Conditions/Comments
	Min	Typ	Max		
SYSTEM SPECS					
Impedance Range	0.001		10	MΩ	
Total System Accuracy		1		%	
System ppm		250		ppm/°C	Vdd = 5.5v@25°C, 500Hz bandwidth
MCLK Update Rate			16	MSPS	System clock update rate
OUTPUT STAGE					
FREQUENCY SPECS					
Output Frequency Range	0		100KHz	Hz	Uni-Polar Sinusoidal Signal at Vout. System accuracy only guaranteed in this range. >100kHz achievable by device but accuracy not guaranteed.
Output Frequency Resolution		27		Bits	<0.1 Hz Resolution achievable using DDS techniques
MCLK					
Initial Frequency Accuracy		0.1		Hz	External Reference Clock. System Output Excitation Frequency Accuracy using external clock/crystal post trim. 0 -100KHz Range.
RC OSCILLATOR					
Initial Frequency Accuracy	10	16.776	17.77	MHz	Internal RC Oscillator. Typically 16.776 MHz
Calibrated Frequency Accuracy		1.5		%	System Output Excitation Frequency Accuracy using internal clock oscillator post trim. 0 - 100KHz Range.
Frequency Tempco		0.1		Hz	0-100KHz Range. 1 point Offset Calibration
Frequency Jitter		35		ppm/°C	Requires 2 point User Calibration.
OUTPUT VOLTAGE SPECS					
AC Voltage Range div by 1		2.0		Volts peak to peak	Pk-Pk Unipolar output excitation Voltage on VOut. Vdd = 5.5v
Output Voltage Error		0.9		%	Voltage Error on Pk-Pk Output Excitation voltage. Vdd = 5.5v
DC Bias (vdd/2)		1.65		Volts	DC bias of AC Signal vdd = 5.5v
DC Bias Error		±9		%	Tolerance of DC Bias
AC Voltage Range div by 2		1.0		Volts peak to peak	Pk-Pk Unipolar output excitation Voltage on VOut. Vdd = 5.5v
Output Voltage Error		0.8		%	Voltage Error on Pk-Pk Output excitation voltage. Vdd = 5.5v
DC Bias (Vdd/4)		0.79		Volts	DC bias of AC Signal vdd = 5.5v
DC Bias Error		±10		%	Tolerance of DC Bias
AC Voltage Range div by 5		0.4		Volts peak to peak	Pk-Pk Unipolar output excitation Voltage on VOut. Vdd = 5.5v
Output Voltage Error		0.7		%	Voltage Error on Pk-Pk Output excitation voltage. Vdd = 5.5v
DC Bias (Vdd/10)		0.32		Volts	DC bias of AC Signal vdd = 5.5v
DC Bias Error		±9		%	Tolerance of DC Bias
AC Voltage Range div by 10		0.2		Volts peak to peak	Pk-Pk Unipolar output excitation Voltage on VOut. Vdd = 5.5v
Output Voltage Error		0.4		%	Voltage Error on Pk-Pk Output excitation voltage. Vdd = 5.5v
DC Bias (Vdd/20)		0.16		Volts	DC bias of AC Signal vdd = 5.5v
DC Bias Error		±7		%	Tolerance of DC Bias
DC Output Impedance (at Vout)		400		Ω	2.0 Vp-p, Output frequency = 30 kHz (external oscillator), vdd= 5.5v, Ta= 25°C

Parameter	Y Version ^{1,2}			Unit	Test Conditions/Comments
	Min	Typ	Max		
DC Output Impedance		2.4		kΩ	1.0 Vp-p, Output frequency = 30 kHz (external oscillator), vdd = 5.5v, Ta= 25°C
DC Output Impedance		1		kΩ	400 mVp-p, Output frequency = 30 kHz, (external oscillator) vdd = 5.5v, Ta= 25°C
DC Output Impedance		600		Ω	200 mVp-p, Output frequency = 30 kHz (external oscillator), vdd = 5.5v, Ta= 25°C
Short Circuit Current (at Vout)		±7		mA	2.0 Vp-p, Output frequency = 30 kHz (external oscillator), vdd = 5.5v, Ta= 25°C
Short Circuit Current		±1		mA	2.0 Vp-p, Output frequency = 30 kHz (external oscillator), vdd = 5.5v, Ta= 25°C
Short Circuit Current		±2.5		mA	2.0 Vp-p, Output frequency = 30 kHz (external oscillator), vdd = 5.5v, Ta= 25°C
Short Circuit Current		±4.5		mA	2.0Vp-p, Output frequency = 30 kHz (external oscillator), vdd = 5.5 V, Ta= 25°C
AC CHARACTERISTICS					
Signal to Noise Ratio		60		dB	Output excitation voltage = 30 kHz, external oscillator mclk = 16.776 MHz, Ta = 25°C vdd = 5.5 V
Total Harmonic Distortion		-52		dB	Output excitation voltage = 30kHz, external oscillator mclk = 16.776 MHz, Ta = 25°C vdd = 5.5v
		-52		dB	Output excitation voltage = 30 kHz, internal oscillator mclk = 16.776 MHz, Ta = 25°C vdd = 5.5 V
Spurious free Dynamic Range (SFDR) Wideband (0 to 1 MHz)		56		dB	Output excitation voltage = 30 kHz, external oscillator mclk = 16.776 MHz, Ta = 25°C vdd = 5.5 V
Narrowband (± 5 kHz)		56		dB	Output excitation voltage = 30 kHz, internal oscillator mclk = 16.776 MHz, Ta = 25°C vdd = 5.5 V
		85		dB	Output excitation voltage = 30kHz, external oscillator mclk = 16.776 MHz, Ta = 25°C vdd = 5.5v
Clock Feedthrough (0 to 17 MHz)		80		dB	Output excitation voltage = 30 kHz, internal oscillator mclk = 16.776 MHz, Ta = 25°C vdd = 5.5 V
		-60		dB	Output excitation voltage = 30kHz, external oscillator mclk = 16.776 MHz, Ta = 25°C vdd = 5.5 V
SYSTEM RESPONSE STAGE					
ANALOG INPUT VIN					
Input Leakage Current		1		nA	To Pin VIN
Input Capacitance		3.5		pF	Pin capacitance between VouT and Gnd = 5.5 V @25°C
Input Impedance		68.5G		Ω	Input impedance between Vout and Gnd = 5.5v @25°C. No feedback resistor connected.
ADC ACCURACY					
Resolution		12		Bits	No missing Codes Guaraunted monotonic
Sampling Rate		1		MSPS	
Integral Nonlinearity		±1		LSB	
Differential Nonlinearity		±1		LSB	
Offset Error					
Gain Error					

Parameter	Y Version ^{1,2}			Unit	Test Conditions/Comments
	Min	Typ	Max		
TEMPERATURE SENSOR					
Accuracy		±1		°C	Ta = -40 °C to 125° c Temperature measurement every 1 sec Vdd = 5.5v
Resolution		0.03125		°C	
Auto Conversion Update Rate		1		sec	
Temperature Conversion Time		800		uS	
LOGIC INPUTS					
Vih, Input High Voltage	0.9		2.3	VDD = 3v	Vdd = 5.5v, Ta = 25°C, Vdd = 5.5v, Ta = 25°C
Vil, Input Low Voltage				VDD = 3V	
Input Current			±4.2	uA	
Input Capacitance			7	pF	
POWER REQUIREMENTS					
Vdd			3.3	Volts	Digital and analog supply currents Digital and analog supply currents
IDD (Normal Mode)		9		mA	
IDD (Powerdown Mode)		0.7		uA	

¹ Temperature ranges are as follows: Y version = -40°C to +125°C, typical at 25°C.

² Guaranteed by design and characterization, not production tested.

TIMING CHARACTERISTICS

Table 3. I²C Serial Interface

Parameter	Limit at T _{MIN} , T _{MAX}	Unit	Description
F _{SCL}	1483	kHz max	SCL clock frequency
t ₁	0.7	μs min	SCL cycle time
t ₂	0.2	μs min	t _{HIGH} , SCL high time
t ₃	0.6	μs min	t _{LOW} , SCL low time
t ₄	0.6	μs min	t _{HD, STA} , start/repeated start condition hold time
t ₅	3	ns min	t _{SU, DAT} , data setup time
t ₆	0.9	μs max	t _{HD, DAT} data hold time
t ₇	0	μs min	t _{HD, DAT} data hold time
t ₈	0.007	μs min	t _{SU, STA} setup time for repeated start
t ₉	0.6	μs min	t _{SU, STO} stop condition setup time
t ₁₀	0.161	μs min	t _{BUF} , bus free time between a stop and a start condition
t ₁₁	55	ns max	t _F , fall time of SDA when transmitting
t ₁₁	0	ns min	t _R , rise time of SCL and SDA when receiving (CMOS compatible)
t ₁₁	300	ns max	t _F , fall time of SDA when transmitting
t ₁₁	0	ns min	t _F , fall time of SDA when receiving (CMOS compatible)
t ₁₁	300	ns max	t _F , fall time of SCL and SDA when receiving
t ₁₁	20 + 0.1 C _B	ns min	t _F , fall time of SCL and SDA when transmitting
C _B	400	pF max	Capacitive load for each bus line

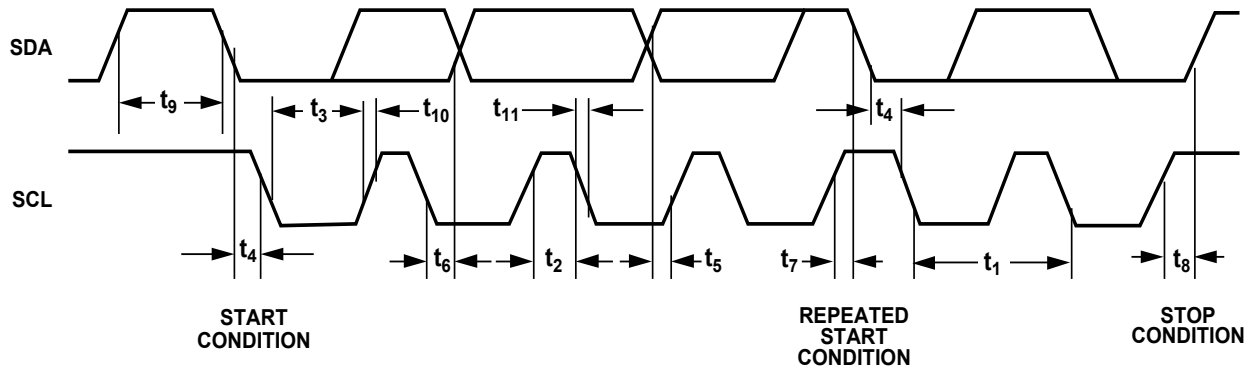

Figure 2. I²C Interface Timing Diagram

03773-0-007

ABSOLUTE MAXIMUM RATINGS

$T_A = 25^\circ\text{C}$, unless otherwise note

Table 4.

Parameter	Rating
V_{DD} to GND	-0.3 V to +7.0 V
Digital Input Voltage to GND	-0.3 V to $V_{DD} + 0.3$ V
V_{OUT} to GND	-0.3 V to $V_{DD} + 0.3$ V
V_{in} to GND	-0.3 V to $V_{DD} + 0.3$ V
Operating Temperature Range	
Extended Industrial (Y grade)	-40°C to +125°C
Storage Temperature Range	-65°C to +160°C
Maximum Junction Temperature	150°C
uSOIC Package	
θ_{JA} Thermal Impedance	332°C/W
θ_{JC} Thermal Impedance	120°C/W
Lead Temperature, Soldering	
Vapor Phase (60 sec)	215°C
Infrared (15 sec)	220°C
ESD	2.0 kV

Stresses above those listed under Absolute Maximum Ratings may cause permanent damage to the device. This is a stress rating only; functional operation of the device at these or any other conditions above those listed in the operational sections of this specification is not implied. Exposure to absolute maximum rating conditions for extended periods may affect device reliability.

ESD CAUTION

ESD (electrostatic discharge) sensitive device. Electrostatic charges as high as 4000 V readily accumulate on the human body and test equipment and can discharge without detection. Although this product features proprietary ESD protection circuitry, permanent damage may occur on devices subjected to high energy electrostatic discharges. Therefore, proper ESD precautions are recommended to avoid performance degradation or loss of functionality.



PIN CONFIGURATION AND DESCRIPTIONS

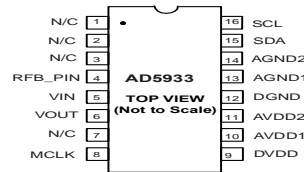

Figure 3. Pin Configuration

Table 5. Pin Function Descriptions

Mnemonic	Description
N/C	No Connect.
RFB_PIN	External Feedback Resistor. This is used to set the gain of the input signal of the VIN node.
VOUT	Input Signal to transimpedance amplifier. External Feedback resistor will control gain of transimpedance amplifier
MCLK	Master Clock for the system. Used to provide output excitation signal and as sampling of ADC.
DVDD	Digital Supply Voltage
AVDD1	Analog Supply Voltage 1
AVDD2	Analog Supply Voltage 2
DGND	Digital Ground
AGND1	Analog Gnd 1
AGND2	Analog Gnd 2
SDA	I ² C Data Input
SCL	I ² C Clock Input.

Table 6. Recommended Pin Connections for AD5933

Mnemonic	Function
Pin 1 Ext_Out	Test Pin—Leave unconnected
Pin 2 NC	No Connect—Do not apply any signal
Pin 3 NC	No Connect—Do not apply any signal
Pin4 NC	No Connect—Do not apply any signal.
Pin5 Vin (Receive side of impedance)	Test Impedance is connected between this pin and vout pin
Pin6 Vout (Excitation side of impedance)	Test Impedance is connected between this pin and vin pin
Pin 7 NC	No Connect—Do not apply any signal
Pin 8 Ext_Clk	Extclk Pad—Only used if external clk option is selected
Pin 9 AVDD1	Recommended to be tied to 3.3V
Pin10 AVDD2	Recommended to be tied to 3.3V
Pin11 DVDD	Recommended to be tied to 3.3V
Pin12 DGND	Must be tied to GND
Pin13 AGND1	Must be tied to GND
Pin14 AGND2	Must be tied to GND
Pin15 SDA	I ² C Data Pin
Pin16 SCL	I ² C Clk Pin

It is recommended to tie all supply connections (Pins 9, 10, 11) and run from a single supply between 3.0 V and 5.5 V. Also, it is recommended to connect all ground signals together (Pins 12, 13, 14).

TYPICAL PERFORMANCE CHARACTERISTICS

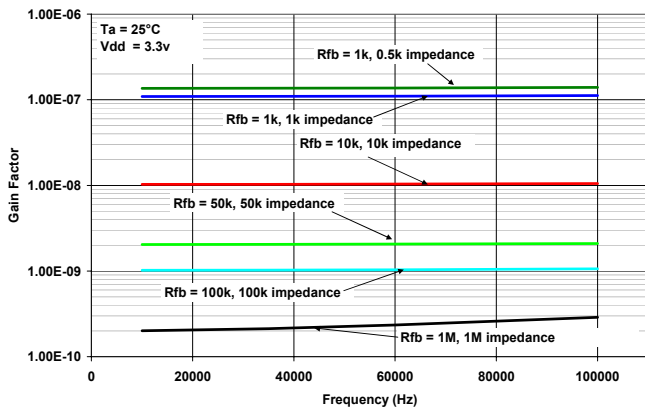

Figure 4. Gain Factor vs. Frequency for Various Rfb/Impedance Ranges

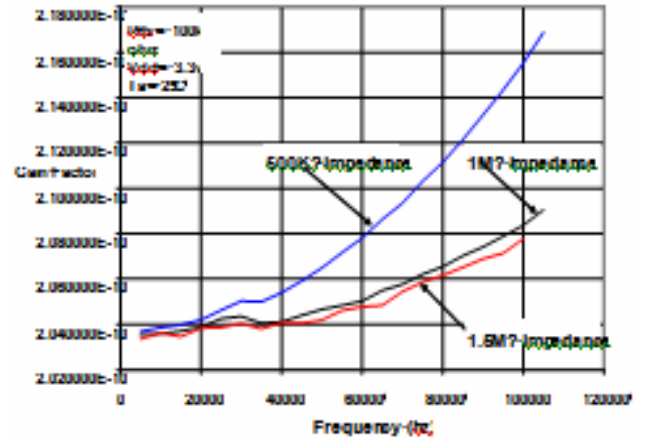

Figure 7. Gain Factor vs. Frequency for 500 kΩ to 1.5 MΩ Impedance Range

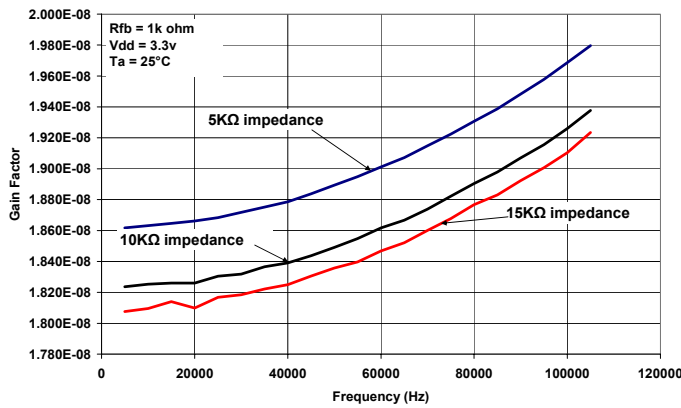

Figure 5. Gain Factor vs. Frequency for 5 kΩ to 15 kΩ Impedance Range

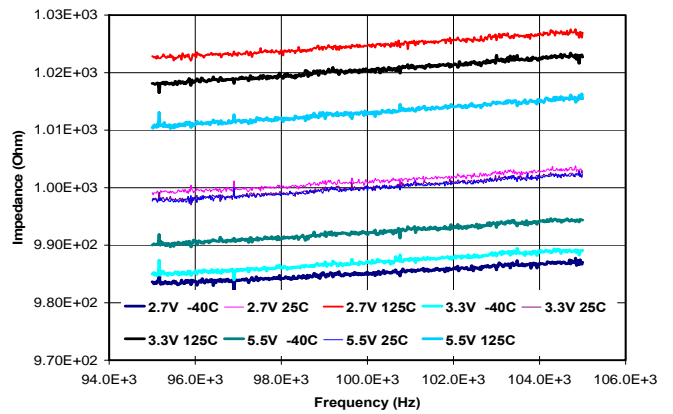

Figure 8. Impedance vs. Frequency for a 1kΩ Rfb Impedance, Gain Factor @100 kHz

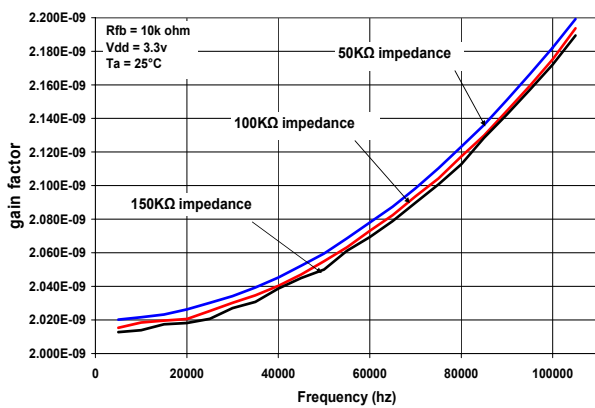

Figure 6. Gain Factor vs. Frequency for 50 kΩ to 150 kΩ Impedance Range

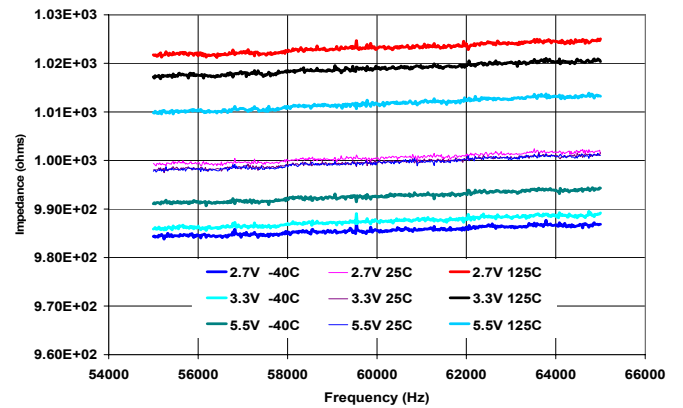

Figure 9. Impedance vs. Frequency for a 1 kΩ Rfb, impedance, Gain Factor @ 60 kHz

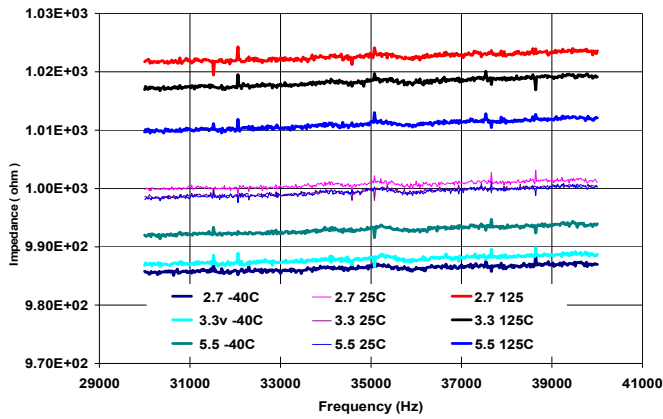

Figure 10. Impedance vs. Frequency 1 kΩ Rfb, Impedance, Gain Factor @ 35 kHz

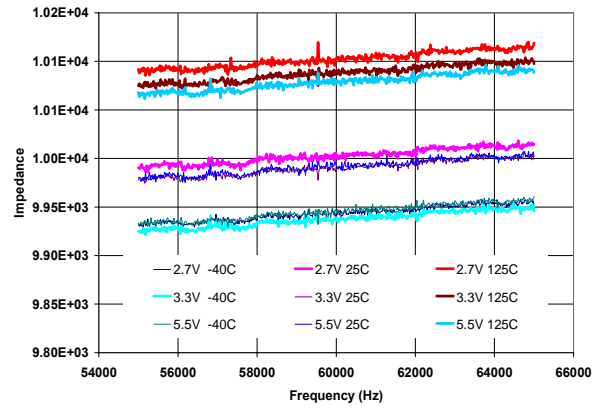

Figure 13. Impedance vs. Frequency 10 kΩ Rfb, Impedance, Gain Factor @ 60 kHz

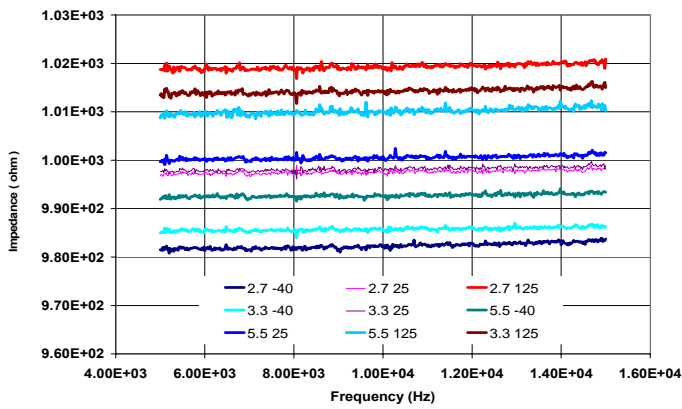

Figure 11. Impedance vs. Frequency 1 kΩ Rfb, Impedance, Gain Factor @ 10 kHz

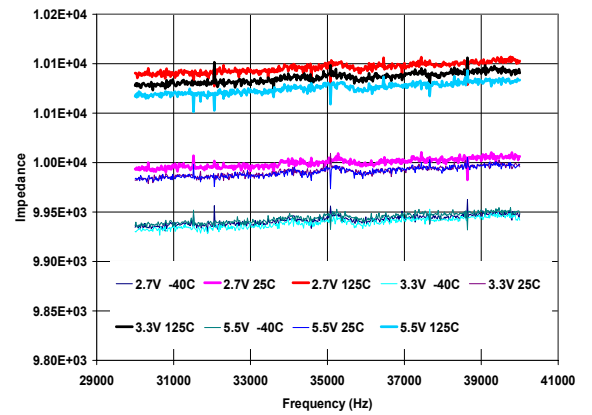

Figure 14. Impedance vs. Frequency 10 kΩ Rfb, Impedance, Gain Factor @ 35 kHz

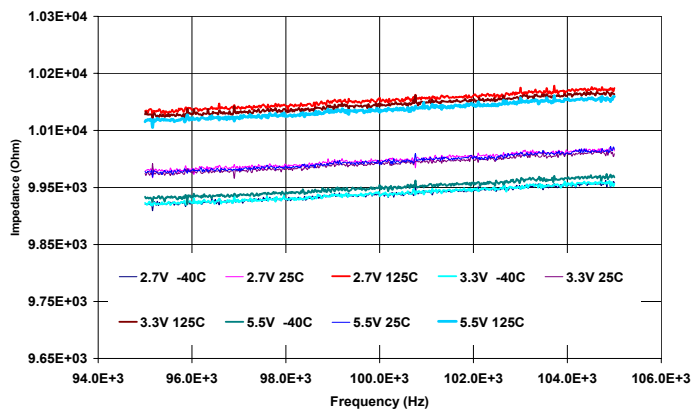

Figure 12. Impedance vs. Frequency 10 kΩ Rfb, Impedance, Gain Factor @ 100 kHz

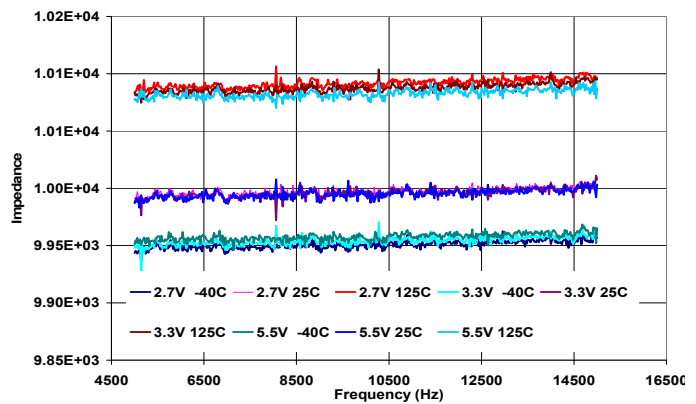

Figure 15. Impedance vs. Frequency 10 kΩ Rfb, Impedance, Gain Factor @ 10 kHz

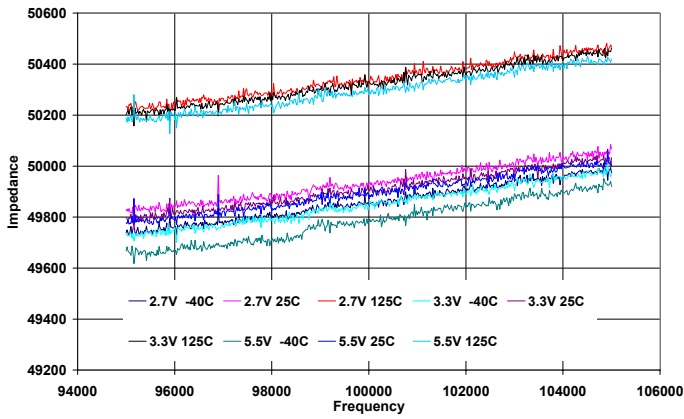

Figure 16. Impedance vs. Frequency 50 kΩ Rfb, Impedance, Gain Factor @ 100 kHz

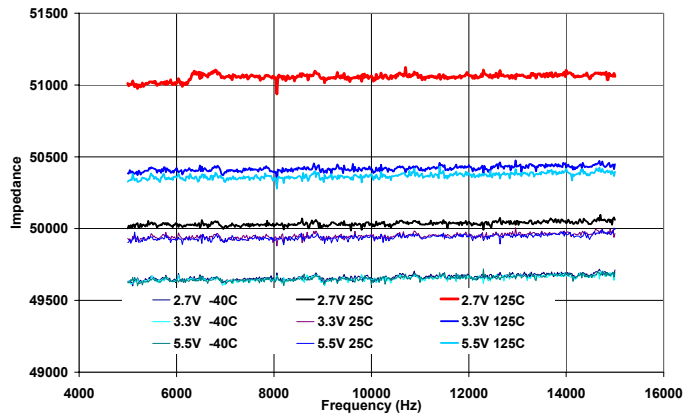

Figure 19. Impedance vs. Frequency 50 kΩ Rfb, Impedance, Gain Factor @ 10 kHz

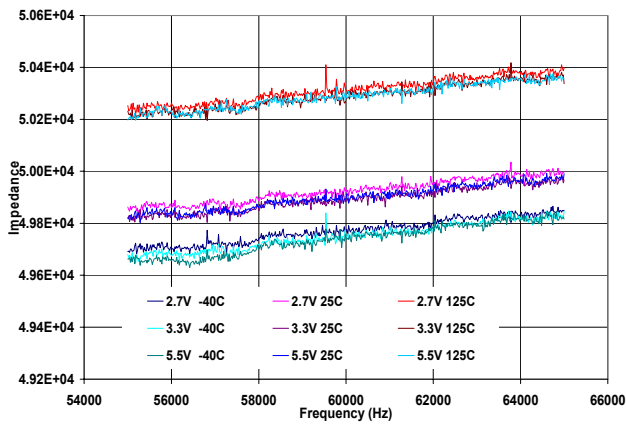

Figure 17. Impedance vs. Frequency 50 kΩ Rfb, Impedance, Gain Factor @ 60 kHz

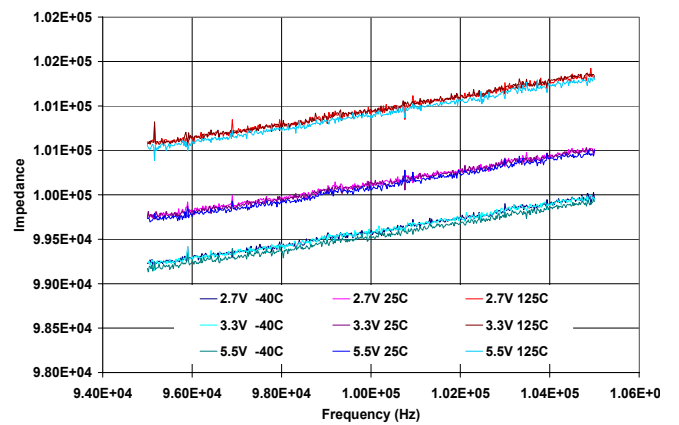

Figure 20. Impedance vs. Frequency 100 kΩ Rfb, Impedance, Gain Factor @ 100 kHz

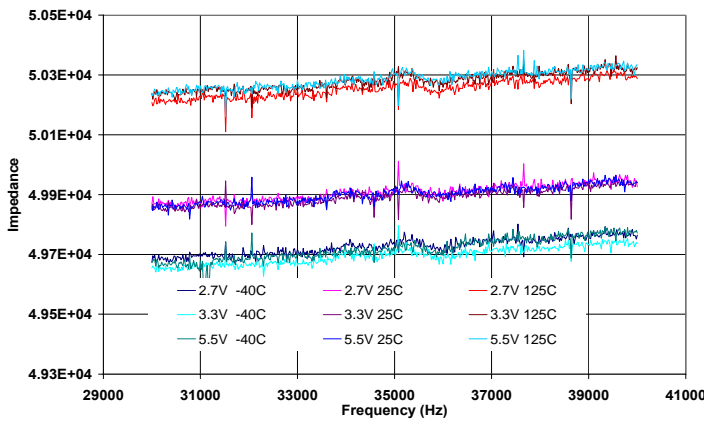

Figure 18. Impedance vs. Frequency 50 kΩ Rfb, Impedance, Gain Factor @ 35 kHz

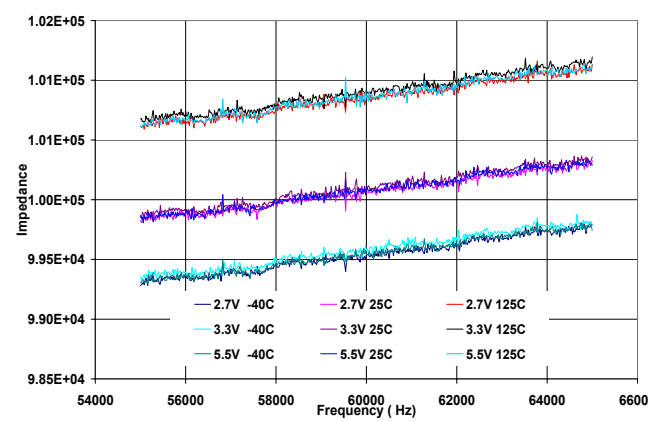

Figure 21. Impedance vs. Frequency 100 kΩ Rfb, Impedance, Gain Factor @ 60 kHz

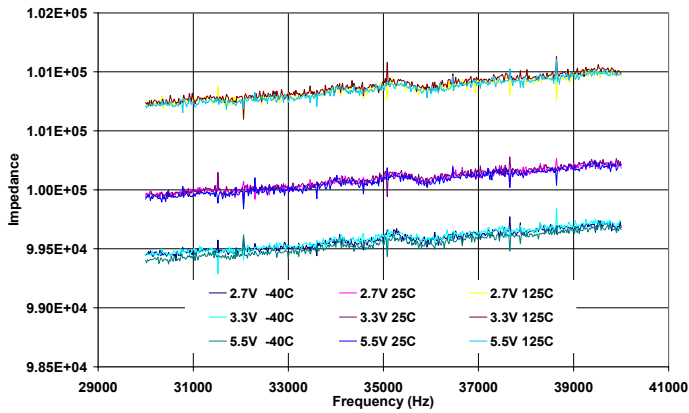

Figure 22. Impedance vs. Frequency 100 kΩ Rfb, Impedance, Gain Factor @ 35 kHz

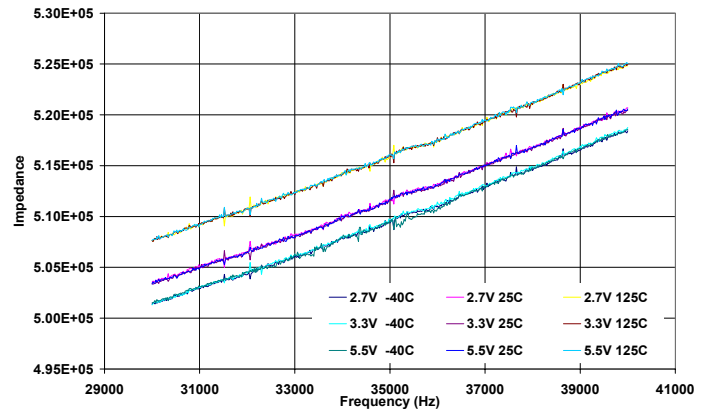

Figure 25. Impedance vs. Frequency 500 kΩ Impedance, Gain Factor @ 35 kHz

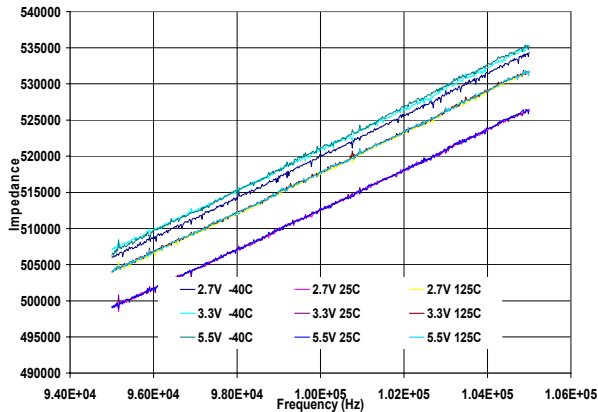

Figure 23. Impedance vs. Frequency 500 kΩ Impedance, Gain Factor @ 100 kHz

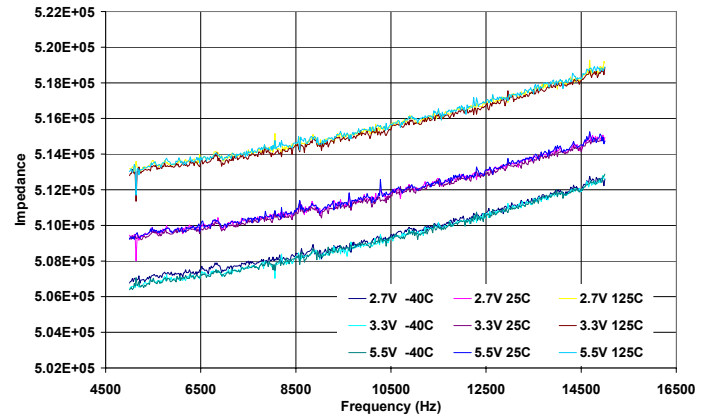

Figure 26. Impedance vs. Frequency 500 kΩ Impedance, Gain Factor @ 10 kHz

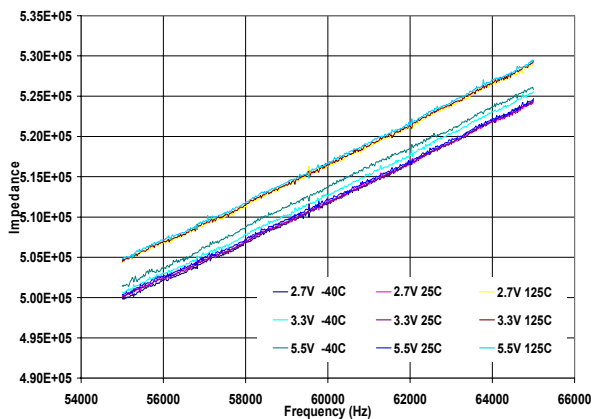

Figure 24. Impedance vs. Frequency 500 kΩ Impedance, Gain Factor @ 60 kHz

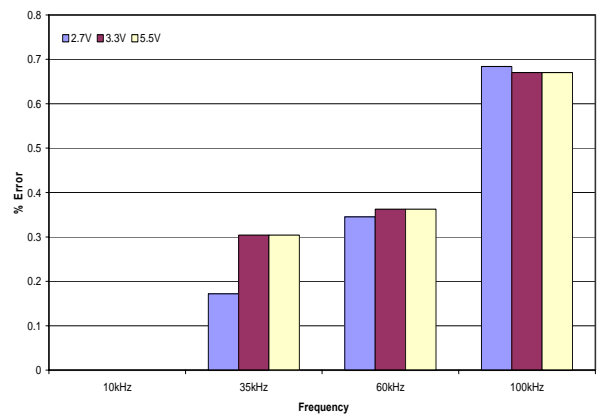

Figure 27. Impedance Error over 10 kHz to 100 kHz Range, Gain Factor @ 10 kHz

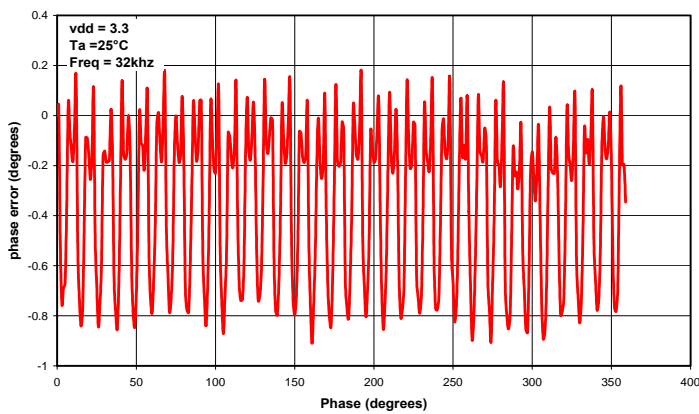

Figure 28. Typical AD5933 Phase Error

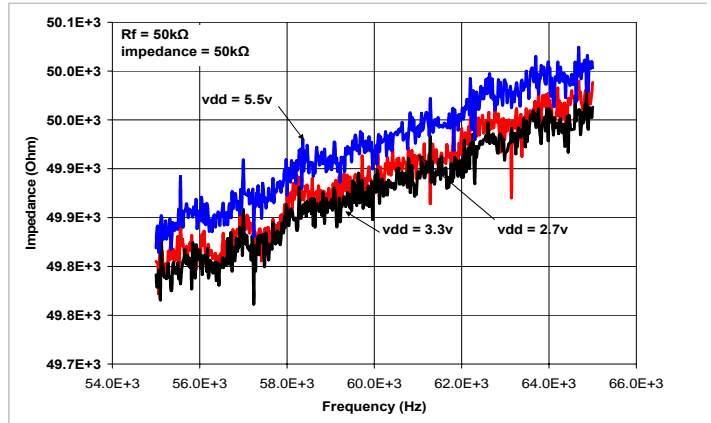

Figure 31. Typical Impedance vs. Frequency for 49.992 kΩ Impedance, Single Point Calibrated Gain Factor @ 60 kHz

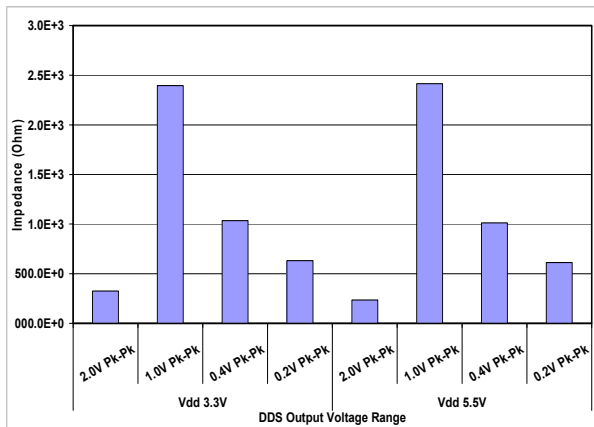

Figure 29. Typical AD5933 Output Impedance

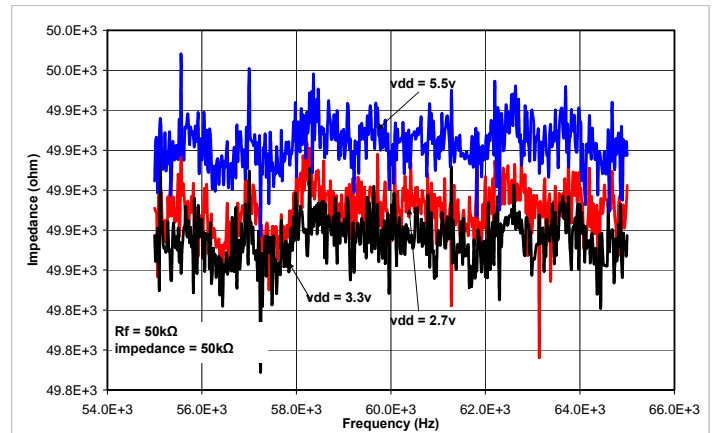

Figure 32. Typical Impedance vs. Frequency for 49.992 kΩ Impedance, End Point Calibrated Gain Factor

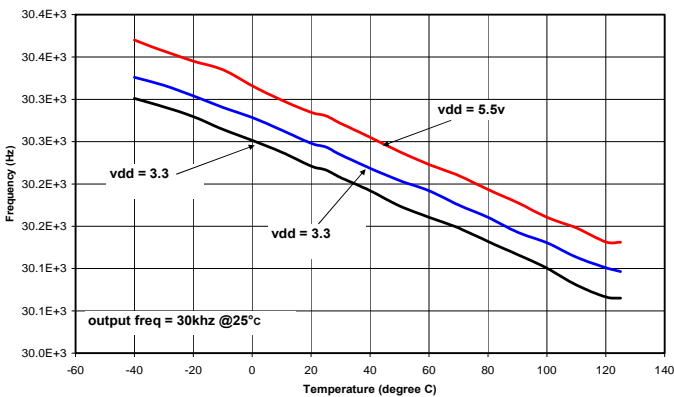

Figure 30. Typical AD5933 Frequency Temperature Coefficient

TERMINOLOGY

DAC/DDS CORE:

Relative Accuracy

For the DAC, relative accuracy or Integral Nonlinearity (INL) is a measure of the maximum deviation, in LSBs, from a straight line passing through the endpoints of the DAC transfer function.

Differential Nonlinearity

Differential Nonlinearity (DNL) is the difference between the measured change and the ideal 1 LSB change between any two adjacent codes. A specified differential nonlinearity of ± 1 LSB maximum ensures monotonicity. This DAC is guaranteed monotonic by design.

Zero-Code Error

Zero-code error is a measure of the output error when zero code (0000 Hex) is loaded to the DAC register. Ideally the output should be 0 V. The zero-code error is always positive in the AD5933 because the output of the DAC cannot go below 0 V. It is due to a combination of the offset errors in the DAC and output amplifier. Zero-code error is expressed in mV.

Full-Scale Error

Full-scale error is a measure of the output error when full-scale code (FFFF Hex) is loaded to the DAC register. Ideally the output should be $V_{DD} - 1$ LSB. Full-scale error is expressed in percent of full-scale range.

Gain Error

This is a measure of the span error of the DAC. It is the deviation in slope of the DAC transfer characteristic from ideal expressed as a percent of the full-scale range.

Total Unadjusted Error

Total Unadjusted Error (TUE) is a measure of the output error taking all the various errors into account.

Zero-Code Error Drift

This is a measure of the change in zero-code error with a change in temperature. It is expressed in $\mu\text{V}/^\circ\text{C}$.

Gain Error Drift

This is a measure of the change in gain error with changes in temperature. It is expressed in (ppm of full-scale range)/ $^\circ\text{C}$.

Digital-to-Analog Glitch Impulse

Digital-to-analog glitch impulse is the impulse injected into the analog output when the input code in the DAC register changes state. It is normally specified as the area of the glitch in nV secs and is measured when the digital input code is changed by 1 LSB at the major carry transition (7FFF Hex to 8000 Hex).

Digital Feedthrough

Digital feedthrough is a measure of the impulse injected into the analog output of the DAC from the digital inputs of the DAC but is measured when the DAC output is not updated. It is specified in nV secs and measured with a full-scale code change on the data bus, i.e., from all 0s to all 1s and vice versa.

Spurious-Free Dynamic Range

Along with the frequency of interest, harmonics of the fundamental frequency and images of these frequencies are present at the output of a DDS device. The spurious-free dynamic range (SFDR) refers to the largest spur or harmonic present in the band of interest. The wideband SFDR gives the magnitude of the largest harmonic or spur relative to the magnitude of the fundamental frequency in the "0" to Nyquist bandwidth. The narrow band SFDR gives the attenuation of the largest spur or harmonic in a bandwidth of ± 200 kHz about the fundamental frequency.

Signal-to-Noise Ratio (SNR)

SNR is the ratio of the rms value of the measured output signal to the rms sum of all other spectral components below the Nyquist frequency. The value for SNR is expressed in decibels.

ADC:**Integral Nonlinearity**

This is the maximum deviation from a straight line passing through the endpoints of the ADC transfer function. The endpoints of the transfer function are zero scale, a point 1/2 LSB below the first code transition, and full scale, a point 1/2 LSB above the last code transition.

Differential Nonlinearity

This is the difference between the measured and the ideal 1 LSB change between any two adjacent codes in the ADC.

Integral Nonlinearity

This is the maximum deviation from a straight line passing through the endpoints of the ADC transfer function. The endpoints of the transfer function are zero scale, a point 1/2 LSB below the first code transition, and full scale, a point 1/2 LSB above the last code transition.

Differential Nonlinearity

This is the difference between the measured and the ideal 1 LSB change between any two adjacent codes in the ADC.

Offset Error

This is the deviation of the first code transition (00 . . . 000) to (00 . . . 001) from the ideal, i.e., AGND + 0.5 LSB.

Total Harmonic Distortion

Total harmonic distortion (THD) is the ratio of the rms sum of harmonics to the fundamental. where V_1 is the rms amplitude of the fundamental and V_2, V_3, V_4, V_5 and V_6 are the rms amplitudes of the second through the sixth harmonics. For the AD5933, it is defined as

$$THD(\text{dB}) = 20 \log \frac{\sqrt{V_2^2 + V_3^2 + V_4^2 + V_5^2 + V_6^2}}{V_1}$$

Gain Error

This is the deviation of the last code transition (111 . . . 110) to (111 . . . 111) from the ideal (i.e., $V_{REF} - 1.5 \text{ LSB}$) after the offset error has been adjusted out.

Signal to (Noise + Distortion) Ratio

This is the measured ratio of signal to (noise + distortion) at the output of the A/D converter. The signal is the rms amplitude of the fundamental. Noise is the sum of all non fundamental signals up to half the sampling frequency ($f_s/2$), excluding dc. The ratio is dependent on the number of quantization levels in the digitization process; the more levels, the smaller the quantization noise. The theoretical signal to (noise + distortion) ratio for an ideal N-bit converter with a sine wave input is given by

$$\text{Signal to (Noise + Distortion)} = (6.02N + 1.76)\text{dB}$$

Thus for a 12-bit converter, this is $\approx 74 \text{ dB}$.

SYSTEM ARCHITECTURE DESCRIPTION

The AD5933 is a high precision impedance converter system solution which combines an on board frequency generator with a 12 Bit 1MSPS ADC. The frequency generator allows an external complex impedance to be excited with a known frequency. The response signal from the impedance is sampled by the on board ADC and DFT processed by an on-board DSP engine. The DFT algorithm returns both a Real (R) and Imaginary (I) data word at each frequency point along the sweep. The impedance magnitude and phase is easily calculated using the following equations:

$$\text{Magnitude} = \sqrt{R^2 + I^2}$$

$$\text{Phase} = \text{Tan}^{-1}(I/R)$$

To determine the actual real impedance value Z (W), generally a frequency sweep is performed. The impedance can be calculated at each point and a frequency vs. magnitude plot can be created like that shown in Figure 33.

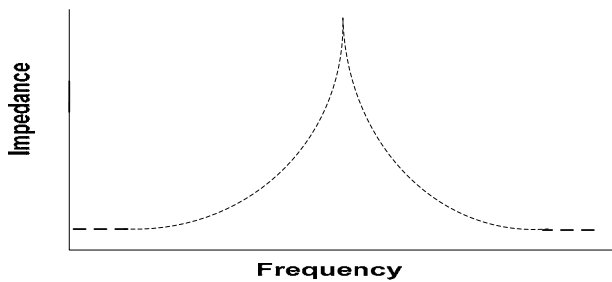

Figure 33.

The system allows the user to program a 2V PK-PK sinusoidal signal as excitation to an external load. Output ranges of 1V, 400mV, 200mV can also be programmed. The signal is provided on chip using DDS techniques. Frequency resolution of 27 bits (less than 0.1HZ) can be achieved. The clock for the DDS can be generated from an external reference clock, an internal RC oscillator. The following section will describe the internal architecture of both the input and output stages of the AD5933.

OUTPUT STAGE

The output stage of the AD5933, shown in Figure 34, provides a constant output frequency or frequency sweep function which has a programmable output voltage of 2/1/0.4/0.2V. The frequency sweep sequence is preprogrammed to the onboard RAM through the I²C interface. An I²C command is used to start the excitation sequence.

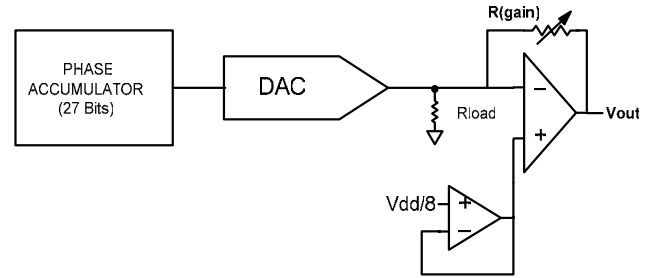

Figure 34.

DDS CORE: CIRCUIT DESCRIPTION

The AD5933 has a fully integrated Direct Digital Synthesis (DDS) core to generate required frequencies. The block requires a reference clock to provide digitally created sine waves up to 50K Hz. This is provided through an external reference clock, MCLK. This clock is internally divided down by 4 to provide the reference clock or fMCLK to the DDS.

The internal circuitry of the DDS consists of the following main sections: a Numerical Controlled Oscillator (NCO), a Frequency Modulator, SIN ROM, and a Digital-to-Analog Converter.

DDS Theory of Operation

Sine waves are typically thought of in terms of their magnitude form $A(t) = \sin(2\pi ft)$. However, these are nonlinear and not easy to generate except through piecewise construction. On the other hand, the angular information is linear in nature. That is, the phase angle rotates through a fixed angle for each unit of time. The angular rate depends on the frequency of the signal by the traditional rate of $2\pi f$.

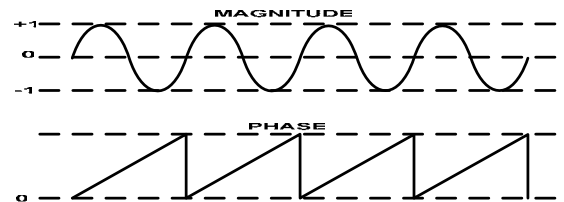

Figure 35.

Knowing that the phase of a sine wave is linear and given a reference interval (clock period), the phase rotation for the period can be determined.

$$\Delta \text{ phase} = w \Delta t$$

Solving for $w = \Delta \text{ phase} / \Delta t = 2 \pi f$

Solving for f and substituting the reference clock frequency for the reference period ($1/f_{MCLK} = \Delta t$)

$$f = \Delta \text{ phase} \times f_{MCLK} / 2\pi$$

The AD5933 builds the output based on this simple equation. A simple DDS core can implement this equation with three major subcircuits: Numerically Controlled Oscillator + Phase Modulator, SIN ROM, and Digital-to-Analog Converter. Each of these subcircuits is discussed in the following section.

NUMERICAL CONTROLLED OSCILLATOR

The main component of the NCO as shown in Figure 36, is a 27-bit phase accumulator. Continuous time signals have a phase range of 0 to 2π . Outside this range of numbers, the sinusoid functions repeat themselves in a periodic manner. The digital implementation is no different. The accumulator simply scales the range of phase numbers into a multi-bit digital word. The phase accumulator in the AD5933 is implemented with 27 bits. Therefore in the AD5933, $2\pi = 2^{27}$. Likewise, the $\Delta Phase$ term is scaled into this range of numbers:

$$0 < \Delta Phase < 2^{27} - 1$$

Making these Substitutions into the equation above

$$f = \Delta Phase \times f_{MCLK} / 2^{27}$$

The input to the phase accumulator is taken from the contents of the start frequency register (see RAM locations 82h, 83h, 84h). Although the phase accumulator offers 27 bits of resolution the start frequency register has the three MSBs set to zero, thus the register only gives 24 bit frequency tune ability to the user whilst retaining 27 bit resolution therefore the minimum clock frequency which can be used for the AD5933 to retain system accuracy is ≈ 500 kHz.

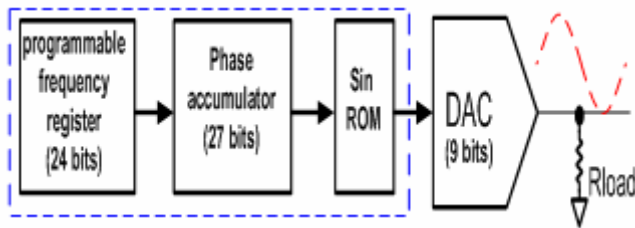

Figure 36.

SIN ROM

To make the output from the NCO useful, it must be converted from phase information into a sinusoidal value. Since phase information maps directly into amplitude, the SIN ROM uses the digital phase information as an address to a look-up table, and converts the phase information into amplitude. Although the NCO contains a 27-bit phase accumulator, the output of the NCO is truncated to 12 bits. Using the full resolution of the phase accumulator is impractical and unnecessary as this would require a look-up table of 2^{27} entries. It is necessary only to have sufficient phase resolution such that the errors due to truncation are smaller than the resolution of the 9-bit DAC.

This requires the SIN ROM to have two bits of phase resolution more than the 9-bit DAC.

DIGITAL-TO-ANALOG CONVERTER & OUTPUT GAIN STAGE

The DDS includes a high impedance current source 9-bit DAC. The output from the DAC is a current (0 – 2 ma, this is ratio-metric with the supply voltage), so in order to develop a current the output current is passed through a precision grounded load resistor such that the output will be a sinusoid voltage. This voltage is subsequently delivered to an inverting gain stage gain stage as shown in Figure 37. The output voltage amplitude from the DAC may be set to a value of 2 V p-p, 1 V p-p, 400 mV p-p or 200mv p-p depending upon the state of switches on the feedback path of the amplifier. Only one switch will be closed at any time. The output voltage amplitude can be programmed by setting bits D10 and D9 in the control register. (See control register section for further details). The output bias voltage of the excitation voltage will also vary depending upon the value of the excitation voltage amplitude set by the user as is summarized in Table 7. The DC bias level is ratio metric with respect to the supply voltage to the AD5933

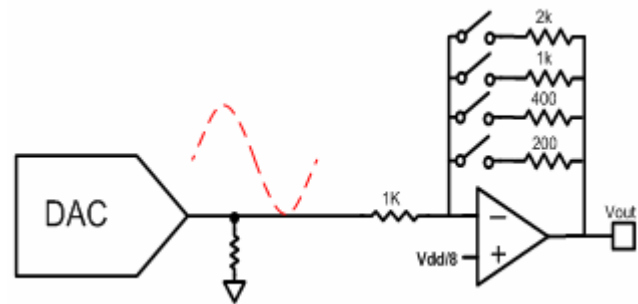

Figure 37.

Table 7.

Output Excitation Voltage Amplitude	Output DC Bias Level
2vp-p	1.6 V (vdd/2)
1vp-p	0.8 V (vdd/4)
400mv p-p	0.32 V (vdd/10)
200mv p-p	0.16 V (vdd/20)

RESPONSE STAGE

The diagram in Figure 38 shows the input stage to pin VOUT. Current from the external sensor/unknown impedance/ load flows through the VOUT pin and into a trans-impedance amplifier which has a user determined external resistor across its feedback path. The feedback resistor is connected between pin 4 and pin 5. The user needs to choose a precision resistor in the feedback loop such that the dynamic range of the ADC is used and that the response signal resides within the linear range of the ADC whilst ensuring the gain factor variation over the impedance and frequency range of interest is minimized. The positive node of the Trans-impedance amplifier and gain amplifier are biased at a fixed value of VDD/2. The output of

the Trans-impedance amplifier can then be gained by either 1 or 5, and is fed directly into the input of the ADC. The value of this pre-ADC gain is determined by the status of bit D8 in the control register.

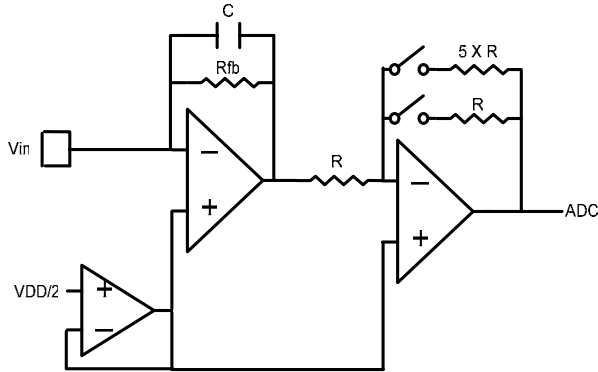

Figure 38.

ADC OPERATION

The AD5933 has an integrated on board 12 bit ADC. The ADC contains an on-chip track and hold amplifier, a successive approximation A/D converter. Clocking for the A/D is provided using a divided down ratio of the reference clock.

The A/D is a successive approximation analog to digital converter, based on a Capacitive DAC design Architecture. Figure 39 shows a simplified schematics of the ADC. The ADC is comprised of control logic, a SAR, and a capacitive DAC, all of which are used to add and subtract fixed amounts of charge from the Sampling capacitor to bring the comparator back into a balanced condition. Figure 39 shows the ADC during its acquisition phase. SW2 is closed and SW1 is in position A, the comparator is held in a balanced condition, and the sampling capacitor acquires the signal on ADC input pin.

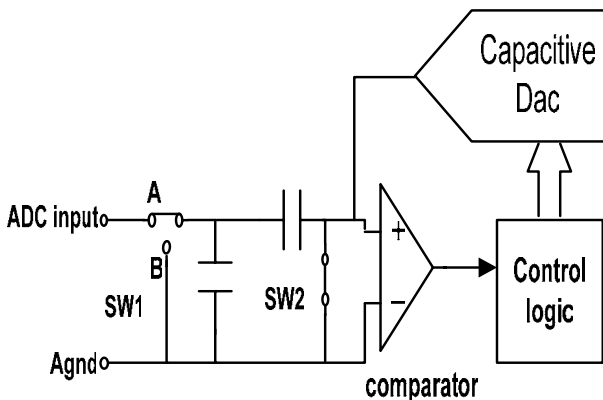

Figure 39.

When the ADC starts a conversion, SW2 will open and SW1 will move to position B, as shown in Figure 40, causing the comparator to become unbalanced. The control logic and the capacitive DAC are used to add and subtract fixed amounts of

charge from the sampling capacitor to bring the comparator back into a balanced condition. When the comparator is rebalanced, the conversion is complete. The control logic generates the ADC output code.

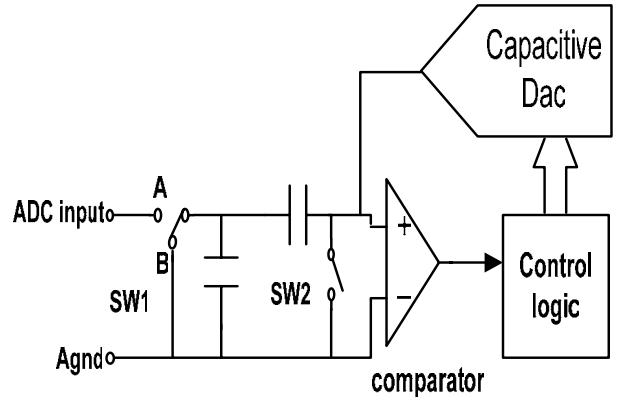

Figure 40.

The start conversion (CS) for the ADC is controlled via an internal gated signal which provides the delay from the start of the excitation signal to the time from which the ADC starts converting the response signal. The gate enable signal is determined by the status of the reset bit, update frequency bit start frequency sweep bit of the control register (80h, 81h).The delay between the time the DDS core outputs the current excitation signal and the time the ADC starts converting the response signal is determined by the value programmed into the “settling time cycles” register and the inherent multiplication factor which maybe performed on this register contents (see ram location 8Ah, 8Bh). The data from the ADC is directly made available to a window coefficient generator prior to being passed to the DSP core of the AD5933 which performs a dft on this windowed sampled data.

DFT CONVERSION

A discrete Fourier transform is calculated for each frequency point in the sweep. The return signal is converted by the ADC, windowed and then multiplied with a test phasor value to give a real and imaginary output. This is repeated for 1024 sample points of the input signal and the results of each multiplication summed to give a final answer as a complex number. The resultant answer at each frequency is two 16 bit words, the real and imaginary data in complex form.

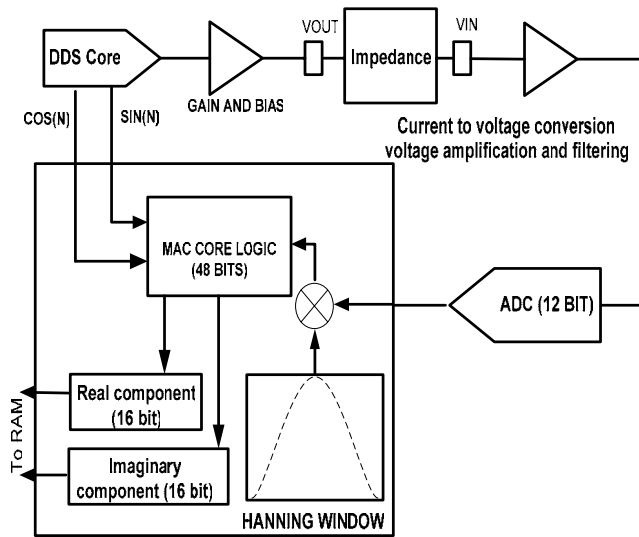

Figure 41.

The DFT algorithm is represented by

$$X(f) = \sum_{n=0}^{1023} (x(n)(\cos(n) - j \sin(n)))$$

Where $X(f)$ is the frequency component corresponding to windowed response sample $x(n)$. The details of the DFT conversion are explained in detail in the section: AD5933: theory of operation. Both the real and imaginary data register have 15 bits of data and one sign bit. The 15 bits of data are in two's complement format. The magnitude of the response signal after each conversion can be calculated by the real and imaginary components returned through the I²C interface

$$\text{Magnitude} = \sqrt{R^2 + I^2}$$

This magnitude which must be calculated off chip is a scaled value of the actual impedance being measured between V_{out} and V_{in} . The multiplication factor between the magnitude returned and the actual impedance value is called the GAIN FACTOR.

Prior to performing a sweep the user will need to calibrate the system in order to set the correct output voltage excitation value, external feedback resistor and pre-ADC voltage gain setting in order to place the response signal in the linear range of the ADC and more importantly such that GAIN FACTOR returned by the setting is accurate. The user calculates this GAIN FACTOR value from the real and imaginary components returned from the device when the calibration impedance is between V_{in} and V_{out} .

$$\text{Gain factor} = \frac{Z_{\text{CALIBRATION}}}{\sqrt{R^2 + I^2}}$$

Where $Z_{\text{CALIBRATION}}$ is a known precision impedance (e.g. precision resistor) value. R and I are the real and imaginary components returned from the AD5933 which has been previously calibrated to set the various gain, bias settings, and external feedback value. The real and imaginary components are stored at location 94h to 97h (see register map)

The calibration impedance should be chosen such that the known impedance lies within the middle of the unknown impedance range. The calibration should be carried out at frequency point which lies in the mid frequency band of interest. The calibration should also be carried out at a temperature which lies in the mid temperature range of interest. The gain factor returned may be subsequently used to recursively calibrate the system. The results returned by the AD5933 may be improved upon by carrying out a two-point calibration. System calibration and the calculation of the gain factor is explained in more detail in section: Gain factor calculation, system calibration

TEMPERATURE SENSOR

The temperature sensor is a 13-bit digital temperature sensor with a 14th bit that acts as a sign bit. The block houses an on-chip temperature sensor, a 13-bit A/D converter and a reference circuit. The A/D converter section consists of a conventional successive-approximation converter based around a capacitor DAC. The on-chip temperature sensor allows an accurate measurement of the ambient device temperature to be made. The specified measurement range of the sensor is -40°C to $+150^{\circ}\text{C}$. At $+150^{\circ}\text{C}$ the structural integrity of the device starts to deteriorate when operated at voltage and temperature maximum specifications.

Temperature Conversion Details

The conversion clock for the part is internally generated, no external clock is required except when reading from and writing to the serial port. In normal mode, an internal clock oscillator runs an automatic conversion sequence. During this automatic conversion sequence, a conversion is initiated every 1 second. At this time, the part powers up its analog circuitry and performs a temperature conversion. This temperature conversion typically takes 800 μs , after which time the analog circuitry of the part automatically shuts down. The analog circuitry powers up again when the 1 second timer times out and the next conversion begins.

The result of the most recent temperature conversion is always available in the serial output register because the serial interface circuitry never shuts down. The temperature sensor block will default to a power-down state. To perform a temperature measurement a command is written to the control register. After the temperature operation is complete, the block automatically powers down until the next temperature command is issued.

In normal conversion mode, the internal clock oscillator is reset after every read or writes operation. This causes the device to start a temperature conversion, the result of which is typically available 800 μs later. Similarly, when the part is taken out of shutdown mode, the internal clock oscillator is started and a conversion is initiated. The conversion result is available 800 μs later, typically. Reading from the device before a conversion is complete causes the block to stop converting; the part starts again when serial communication is finished. The result of the most recent temperature measurement is available to read at register location 92h and 93h via the I²C interface. See register map for more details on the register contents.

Temperature Value Register

The temperature value register is a 16-bit read-only register that stores the temperature reading from the ADC in 13-bit two complements format plus a sign bit. The two MSB bits are don't cares. D13 is the sign bit. The ADC can theoretically measure a 255°C temperature span. The internal temperature sensor is guaranteed to a low value limit of -40°C and a high limit of +150°C.

Table 8. Temperature Data Format

Temperature	Digital Output DB13...DB0
-40°C	11, 1011 0000 0000
-30°C	11, 1100 0100 0000
-25°C	11, 1100 1110 0000
-10°C	11, 1110 1100 0000
-0.03125°C	11, 1111 1111 1111
0°C	00, 0000 0000 0000
+0.03125°C	00, 0000 0000 0001
+10°C	00, 0001 0100 0000
+25°C	00, 0011 0010 0000
+50°C	00, 0110 0100 0000
+75°C	00, 1001 0110 0000
+100°C	00, 1100 1000 0000
+125°C	00, 1111 1010 0000
+150°C	01, 0010 1100 0000

Temperature Conversion Formula

1. Positive Temperature code = $ADC\ Code(decimal)/32$
2. Negative Temperature code = $(ADC\ Code(decimal) - 16384)/32^*$

Negative Temperature = $(ADC\ Code(d)^{**} - 8192)/32$

*D13 (sign bit) is removed from the ADC code

**Use all 14 bits of the data byte, including the sign bit.

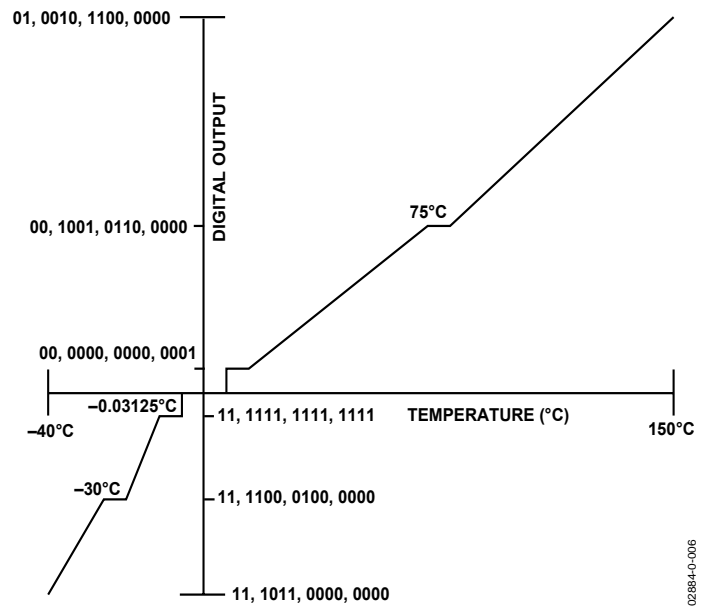

Figure 42. Temperature to Digital Transfer Function

02884-C-006

AD5933 THEORY OF OPERATION

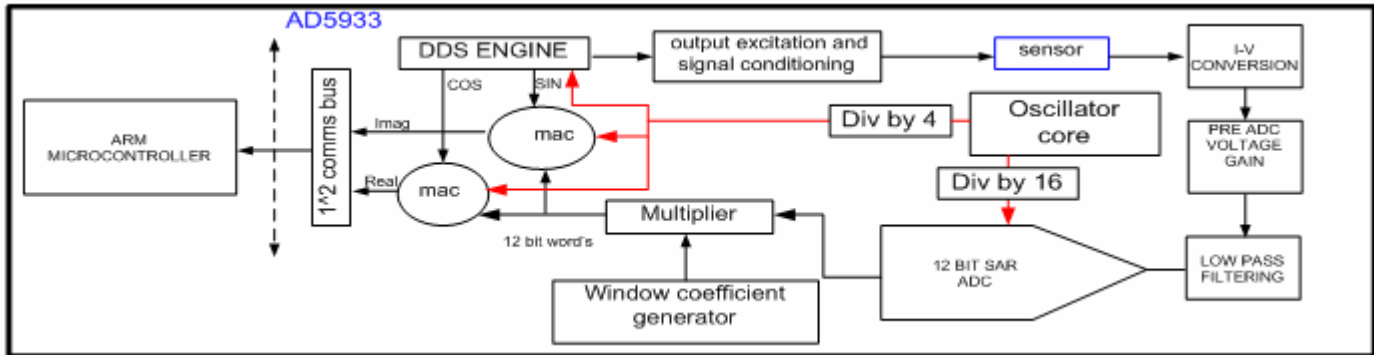

Figure 43. AD5933 Block Overview

OSCILLATOR CORE

The AD5933 has an on chip RC oscillator implemented as shown in the above diagram, it has an output frequency of 16.7 MHz ± 0.2 MHz (period T=60 ns) with a ± 330 ppm jitter spec. The user can also supply an accurate 16.6 MHz clock externally to pin 8. The user can select the system clock to be either the 16 MHz internal clock oscillator or the external crystal/clock if connected, by setting bits D3 and D2 in the control register. From the above diagram it can be seen that the base clock drives the digital engine, the clock is divided down by 4 for the DDS and by 16 for the ADC.

DDS CORE

The DDS allows for a 0.1 Hz resolution frequency output which the user can program via a 24 bit word, loaded serially over the I²C interface. The word loaded is the result of a simple formula shown in equation 1, based on the master clock frequency and the desired frequency output of the DDS.

$$required\ code = \left\{ \left(\frac{DDS\ Output\ Frequency}{\left(\frac{Mclk}{4} \right)} \right) \times 2^{27} \right\}^{Eqn(1)}$$

In addition the DDS provides both the sin and cosine coefficients for the DFT operation. These coefficients are applied to the Multiply/Accumulate (MAC) blocks on every rising edge of the system clock. One of the generated sinusoids is simultaneously converted into a voltage waveform by passing the output of the phase accumulator core to a high impedance output current DAC with a precision load resistor to ground on the output. The output of the DDS/DAC is a current from 0 to 2 mA. This current is passed through a grounded precision resistor such that maximum voltage by default is ± 2 V peak to peak. This voltage is applied to the VOUT pin. There is the provision for dividing down this voltage as the application requires. By writing to the control register, the user can set this

voltage applied to VOUT to be a divide by 10, 5 or 2 (200mV p-p, 400mVp-p, 1Vp-p by setting bits D10, D9 of the control register. The DC bias level changes on the output excitation voltage will change according to the selected output amplitude value programmed as shown in Figure 44.

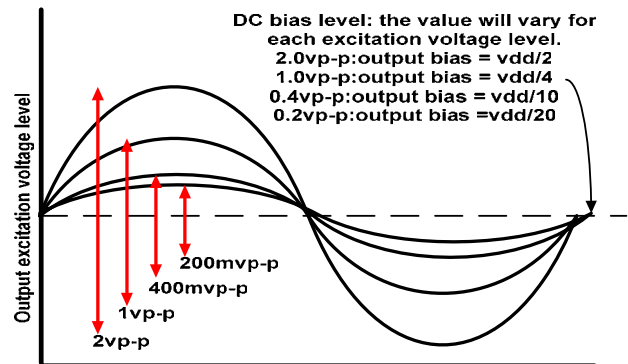

Figure 44. Output Excitation Voltage Levels and Bias Values

The DDS can be programmed with a start frequency, a frequency increment, a delay to allow a complex impedance system to settle and the ability to repeat the same frequency point multiple times (for example in the event of an interface error). The complex impedance network to be excited by the DDS output voltage is connected between VOUT (pin 6) and VIN (Pin 5).

ANALOG CHANNEL AND FILTER NETWORK

The output of the complex impedance network is applied to VIN (pin 5). This is the input node to an Trans impedance amplifier with a feedback resistance determined by the user Rfb—thus the gain of this first amplifier is $R_{fb}/Z(w)$, where $Z(w)$ is the value of the impedance under test, for example, if the value of Rfb is chosen to be 200 k Ω and the value of the complex impedance at a given frequency say 100 kHz is 1M Ω , then this first amplification stage would be an attenuation of 0.2. The second stage of amplification can be either a gain of 1 or a gain of 5. The gain of 5 would correct the above mentioned attenuation, the gain of one is necessary when large impedances between Vout and Vin are to be measured, as the signal into the ADC has to be controlled so as not to go outside its dynamic range. The gain of 5 and gain of 1 is user programmed via bit D8 of the control register. After the gain stage the signal is buffered and has to settle a pre ADC sampling cap (~12p) to 12 bits within 180 ns) and filtered before it is applied to the 12-bit SAR ADC. Filter poles have been designed into the channel to roll of noise. In addition to this, the subsequent DFT operation narrows bands noise to -3 dB at freq ± 1 kHz (2 kHz noise band width) around the DDS output drive frequency, due to an integrated hanning window function (see dft and windowing).

THE ANALOG-TO-DIGITAL CONVERTER

The function of the ADC is to implement the digitization of the return signal from the complex network for use with DFT. The ADC samples the return signal at 1 MHz, and provides the samples to the digital engine. The details of the ADC are explained in the section: system architecture description.

THE DISCRETE FOURIER TRANSFORM

The AD5933 method of determining the amplitude of the sensor/impedance network signal involves the use of the DFT. The DFT is a purely digital approximation of the Continuous Fourier Transform. It takes a number N, of samples from a time domain signal (the sine-wave in this case $x(t)$) and returns the spectral content of that signal as a complex number $R + jI$. These complex numbers describe the $x(t)$. The DFT offers excellent dc rejection, an averaging of errors and provides the phase information. The AD5933 implemented DFT assumes that a sequence of periodic data samples $x(n)$ of which we wish to determine the spectral content of the original continuous excitation signal on Vout. These samples come from the 12-bit ADC which has the complex impedance/sensor signal as its input, for a range of signal-frequency values. The method employed differs from the conventional DFT, in that only a single frequency bin is transformed, rather than a fundamental and its harmonics—it's a single-point DFT.

With the conventional DFT, a sequence of input samples is correlated with samples from a phasor. The frequency of this phasor is at integer multiples of a fundamental frequency given

by f_s/N . The correlation is performed for each frequency multiple, if the resulting correlation of the phasor (consisting of both a sine and a cosine at that multiple frequency) is non-zero, then we can deduce that there is energy in the input signal at that particular frequency bin. (Dividing the frequency axis into n , equally spaced analysis phasor-bins is common in DFT analysis). If no energy is found in a bin then there can be no energy at that test frequency. With the single-point DFT the analysis frequency is always the same as the input frequency (by design), we are only looking for energy at one particular frequency. So we only perform the DFT for one frequency bin, which is fixed for the particular input frequency.

For example, if the complex impedance is excited with a 27K Hz sinusoid, then the output of the complex impedance is sampled and quantized. The resulting sample values are then used as the input values to the DFT, which uses an analysis frequency (from the DDS) also at 27K HZ. What this effectively does is correlate the output voltage samples with the test phasor. For a coherent system this will give us back exactly the correct answer in the form of a single complex number ($R + jI$).

In rectangular or trigonometric form, the DFT has the form shown in Equation 1.

$$X(m) = \sum_{n=0}^{N-1} x(n) \left(\cos\left(\frac{2\pi mn}{N}\right) - j \sin\left(\frac{2\pi mn}{N}\right) \right)^{Eqn(2)}$$

where:

$X(m)$ is the m^{th} DFT output, corresponding to the complex output for that input sample.

m is the index of the DFT outputs component in the frequency domain.

n is the time-domain index of the input samples—both n, m 0,1,2... $N-1$

N is the number of samples in the input sequence that will be transformed to the frequency domain, and the number of frequency points in the DFT output.

$x(n)$ is the discrete sequence of time-domain sampled values of the continuous waveform. (The ADC output in this application), The number of points taken for the DFT, that is, the DFT length N is an important number, it determines both the accuracy of the final result and the complexity of the circuitry required to calculate the results.

To highlight the dft with an example, assume the following values.

- Sampling Frequency = 1 MHz = F_s
- $N = 1024$
- Input Signal = $A \sin(2\pi ft + \phi)$
- $A = 1, f = 27k \text{ to } 32k, t = 1/F_s, \phi = 0$

The conventional DFT returns the spectral content at discrete frequency bins given by F_s/N = roughly every 1K Hz in this case. For N input (time-domain) samples the DFT will return N frequency-domain results in complex - or rectangular form, a real and an imaginary component. The simplified sequence of events that results in a DFT is as follows.

1. DDS outputs a single frequency of amplitude A and phase \emptyset .
2. For each value output from the DDS ($A \sin(2f\pi n/N)$), where $n = 0 \dots N-1$, the DDS also passes the \cos and \sin of this value to the DFT multiply and Accumulator block (MAC).
3. The MACs (one for both the \sin and \cos) will multiply the values passed by the DDS with the sampled values returned from the sensor/network (which has been multiplied with a hanning window function—see below for further details)
4. This is repeated for N samples.
5. After N cycles the values in the MACs contain the digital equivalent of the real ($\cos * x(t)$) and imaginary ($\sin * x(t)$), DFT output values. This is essentially a correlation of the response signal with the current DDS output waveform.
6. These values are transmitted to the off-chip by the user to a microcontroller where the real and imaginary components are conditioned into an impedance of the sensor/impedance network for that particular frequency.
7. The process is repeated for point along the frequency sweep range conditions programmed into the AD5933 RAM (see section on AD5933 registers for further details)

Subsequently the microcontroller will process the data returned from AD5933 for each sweep point to extract the Impedance.

AD5933 DISCRETE FOURIER TRANSFORM LEAKAGE

Leakage causes the DFT results to be only an approximation of the true spectra of the original input signal. DFTs are constrained to operate on a finite set of N input values sampled at a sample rate of F_s , to produce an N -point transform whose discrete outputs are associated with the individual analytical frequencies, that are integer multiples of $(m * F_s)/N$. The problem is that the DFT only produces correct results when the input data sequence contains energy precisely at the analysis frequencies that are integral multiples of the fundamental frequency. If the input signal has a component at some intermediate frequency between these frequency bins, this input signal will show up to some degree in all of the N output frequency bins of the DFT. In a conventional DFT this can have the undesirable effect of masking out weaker signals that are present close to stronger ones in the input signal.

Leakage is caused by the discontinuities caused by the DFT assuming a periodic input signal. If the input signal does not have an exact integral number of cycles over the N -point sample interval then we will not have a smooth transition from the end of one period to the start of the next. Firstly the very fact that a finite number of points have been sampled to form the DFT, we are in effect multiplying the input sequence by a rectangular window of an assumed infinite signal in the time domain. The CFT of a rectangular function is the sinc function (which we approximate with the DFT), and if the input signal contains components at exactly integer multiples of the fundamental analysis frequency, then these side lobes will be zero at bin frequencies and will not show up in the DFT output. If however, the input signal contains components that do not fall exactly on these bin frequencies, then the sinc functions side lobes will contain energy at the bin frequencies. It is the high-frequency components inherent in the discontinuities of non-periodic sampling that causes these side lobes to exist.

In the single-point DFT that the AD5933 is concerned with, the sampling frequency for this is set at 1 MHz, and $N = 1024$. This gives bin frequencies at integer multiples of ~ 1 kHz. So if we wanted accurate DFT outputs, the input signal would be restricted to 1 kHz multiples – the resolution of the DFT is said to be 1 kHz, i.e., the DFT will only give the correct results for these frequencies locations. Because for the AD5933 the input signal can take on *any* value, the leakage effects must be considered

The most popular method for reducing the effects of spectral leakage is windowing. Windowing has the effect of reducing the energy contained in the side lobes of the sinc function. When the input signal does not contain an integer number of cycles within the sample interval we will have leakage as described above. AD5933 Applications may have the additional problem of a non-periodic analysis frequency. A conventional DFT is performed with analysis phasors that are multiples of the fundamental bin frequency given by F_s/N . Because the AD5933 is only performing a single-point DFTs, this is no longer the case. The analysis phasors are not periodic between bin-frequencies. In addition we also end up with cosine and sine squared function when building up the DFT results. The result of this is the unusual ripple that is seen on the output values between bin frequencies. Windowing will reduce these effects considerably.

The AD5933 uses the Hanning window to achieve the system accuracy The Hanning window equation is an inverted, raised cosine of half-unit amplitude peak to peak as shown in Equation 3.

$$Hanning(n) = \frac{1}{2} - \frac{1}{2} \times \cos\left(\frac{2\pi \cdot f \cdot n}{N}\right) \text{Eqn. (3)}$$

Where f = the sampling interval and, $n = 0 \dots N-1$, and N = DFT length.

The Hanning window offers good side lobe rejection and due to its symmetrical properties is efficient to implement in a digital engine. The window function will reduce the discontinuities at the end of the sampling interval period and the start of the next period (in the time domain), and forces the input time sequence at both the beginning and end of the sample interval to go smoothly towards a single common amplitude value. As the output of the DFT is periodic, the periods will line up better, with less of a transition from the last sample value to the first sample of the next period resulting in less energy in the side lobes of the sinc function.

Hanning Windows also have the effect of reducing the time-domain signal levels applied to the DFT; as such the main lobe peak values are reduced (-13 dB) relative to the unwindowed input data sequence. This leads to a predictable processing loss that must be accounted for (with a multiplier value) when computing the windowed DFT output values. Windowing in the conventional sense will also widen the main lobe width, reducing the resolution of the data, leakage effects are reduced, but this doesn't become a problem for AD5933 single-point DFT.

The input data samples from the ADC are windowed, that is, they are multiplied by a set of coefficients that are calculated from the window function on a point for point basis. The data samples take on the tapered profile of the window. In hardware terms this is performed in the digital engine (just a multiplier of sufficient bit width). The actual DFT operation must then be done – the windowed samples are point for point multiplied with both the sin and cosine values from the DDS and a multiply and accumulate operation is performed in the digital engine to give us the DFT result.

$$X(f) = \sum_{n=0}^{N-1} \{(\sin(n) \times x(n)) + (\cos(n) \times x(n))\} \quad \text{Eqn (4)}$$

For N values where N=1024.

The above general equation outlines what is done on each data sample where f is the test frequency.

GAIN FACTOR CALCULATION

The AD5933 device is capable of measuring impedances values to within 1% for impedances which lie within the range of 100Ω to 10MΩ. The DFT of the response signal from the unknown impedance will return both a 16 bit twos complement real and an imaginary word for each frequency point on the sweep. Each of the data components is stored in a single 16 bit register location (see register map). The user must read these values to an off chip microprocessor/DSP through the I²C interface in order to calculate the impedance value at each point. The user must poll the status register to see when there is valid data available to read and finally to check if the entire frequency sweep has been completed. Once valid data has become available the user must read the current contents of the real and imaginary data register before the next frequency sweep point has updated the current contents with new valid data.

The magnitude of the real and the imaginary data contents each frequency point is given by the following

$$\text{Magnitude}(f) = \sqrt{R^2 + I^2}$$

Where R and I correspond to the real and imaginary code returned for the current sweep point.

This magnitude value is equal to a scaled value of the actual impedance under test at the frequency point f. In order to determine actual impedance value the user must multiply the magnitude by a Gain Factor GF(freq, Vdd, temp). Therefore the actual impedance any sample instant is given by the following

$$\text{Impedance}(f) = \text{Gain Factor} \times \text{Magnitude}(f)$$

The Gain Factor is measured using a known external impedance, e.g., a precision resistor, connected between Vout and Vin as close as possible to the pins. Calculating the gain factor in this way calibrates out the parasitic impedance between Vout and Vin at a given frequency. The parasitic impedance is made up of a parallel capacitance between Vout and Vin as well as a series resistance and series inductance mainly due to the bond wires and solder joints. The value of the known calibration impedance e.g. precision resistor is measured prior to connecting between Vout and Vin. This value acts as the reference for calculating the gain factor. The gain factor is given by the following formula

$$\text{GainFactor}(f) = \frac{\text{Admittance}}{\text{Code}} = \frac{1}{\text{Code} \times \text{Calibrated Impedance}}$$

$$\text{Code} = \sqrt{R^2 + I^2}$$

The gain factor is an Admittance per code value. It is mathematically calculated by dividing the known measured Calibration impedance between Vout and Vin by the Magnitude

of the code returned by the DFT at a single frequency chosen and by the user. This constitutes a single point gain factor calibration. The Gain Factor is measured at a particular frequency in the mid range of the frequency of interest. The calibration impedance should be chosen by the user to lie in the middle of the unknown impedance range and also in the middle of the temperature range of interest. The gain factor essentially is a number representing the accumulative gain through the signal path of the system for known measured calibration impedance and for a specified value of output voltage excitation value and frequency/pre ADC gain setting and feedback resistor chosen by the user. Therefore the Gain factor will depend upon the frequency point at which it is calculated, the AD5933 supply voltage, as the output bias level is ratio metric with respect to the supply Vdd (see Table 7), the device temperature as the gain of the Internal operational amplifiers will drift with temperature, the value of the external feedback resistor will set the gain given by $|r_{fb}/Z_{\text{calibration}}|$ of the trans-impedance Amplifier and so effect the value of the system gain.

As all the gains of the system are located on the signal path and so any adjustment to the supply voltage, calibration frequency, output excitation level, external feedback resistance value, and pre-ADC voltage gain will require a recalculation of the Gain factor. If the gain factor is not recalculated after any system gain parameter adjustment then the Impedance value returned by the AD5933 will have an error associated with it. Therefore the accuracy of the end result will depend upon the value of the gain factor.

The gain factor is calculated at a single frequency in the middle of the frequency range of interest at a known supply and temperature after the system has been calibrated i.e. set the correct output excitation voltage, frequency, pre ADC gain value and correct rfb value for the impedance range under test.

The gain factor will vary in a linearly fashion as the sweep deviates from the point at which the gain factor was calibrated, provided the other system gain parameters remain constant i.e. temperature, supply, feedback resistor etc. A typical gain factor vs. frequency plot is shown in Figure 8 for various values of impedance and feedback resistors. The frequency point at which the gain factor was calculated will return an impedance value with zero error provided the system has been correctly calibrated i.e. setting the correct output excitation voltage, pre ADC gain value and external feedback resistor. The gain factor deviates linearly with frequency; the subsequent error in the impedance values returned by the AD5933, introduced by the deviation from the calibration point frequency will vary in the same linear fashion.

If however the user performs a frequency sweep to determine the impedance profile of the network under test / sensor using a calibrated gain factor calculated in the middle of the frequency

and temperature range of interest as recommended i.e. performs a frequency sweep using a calibrated single point gain factor, the absolute error returned by the AD5933 as the frequency moves from the calibration frequency point can be reduced by performing a two point calibration. Figure 4 shows that the Gain Factor variation over frequency is approximately linear. Thus another frequency dependant term may be used to correct for the impedance error as follows.

$$GF(f) = GF(f_{mid}) + \Delta GF$$

$GF(f)$ = Frequency Corrected Gain Factor

$GF(f_{ref})$ = Gain Factor measured at mid range frequency

ΔGF = Change in Gain Factor per 1Hz change in frequency

ΔGF may be calculated from the slope of the GF V's frequency profile. The impedance may then be recalculated using the corrected Gain Factor as follows.

$$Z(f) = \frac{1}{(GF(f_{mid}) + \Delta GF(f)) \times (f - f_{mid})}$$

$$\Delta GF(f) = \Delta GF \times (f - f_{mid})$$

Figure 32 shows the improvement achieved in accuracy due to frequency independent Gain Factor.

The gain factor varies with temperature; therefore the system accuracy will vary with Device temperature. A typical impedance vs. temperature plot is shown in Figure 9. The gain factor will also vary with the supply voltage due to the fact that the peak to peak excitation voltage and the output bias levels are ratio metric with respect to supply.

AD5933 SYSTEM CALIBRATION

The gain factor (explained above) essentially is a number representing the accumulative gain through the signal path of the system for known calibration impedance for a specified value of output gain voltage/pre ADC gain and feedback resistor settings. By calibrating the device with a value of known impedance connected between Vout and Vin you are associating the digital output code of the AD5933 with this known impedance value. By calibrating the system with this known impedance you are also inherently calibrating for the internal system gains along the system signal path. The gain factor calculated (see section: gain factor calculation) from the resulting code returned at a mid frequency calibration point of interest will allow you to calculate the impedance value of the network under test to less than 1% within an impedance range of 5kΩ on either side of the calibration value. The resultant absolute error returned from using this single point gain factor as the sweep frequency deviates from the calibration point can be reduced further as a result of carrying out a two point calibration (see: gain factor calculation for more details).

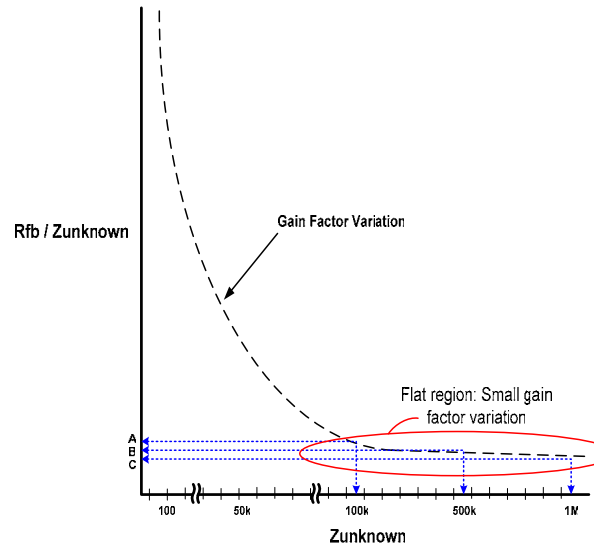

Figure 45. Typical Gain Factor Variation for Various rfb/Z Unknown Impedance Ranges

The gain factor is dependant upon the ratio of the trans-impedance feedback resistance value RFB to the impedance under test ($Z_{unknown}$). The shape of this variation is shown in Figure 45. When calibrating the system the values of the feedback resistance should be chosen such that ratio $Rfb/Z_{unknown}$ lies with in the flat region of the characteristic marked by a red ellipse in Figure 45. In order for the AD5933 to return accurate values, it is necessary to ensure that the largest signal is returned to the ADC whilst ensuring that gain factor will not vary significantly over the unknown impedance range. Minimising the gain factor variation is achieved by placing the AD5933 operating point in this flat region as indicated in Figure 45 in this flat region the variation of the gain factor for the unknown impedance range will be minimised. The ratio of feedback resistor to Calibration impedance should lie in the range of 0.2, 0.1 and 0.066 shown as points A, B and C in Figure 45. The output excitation voltage is programmable to be 2 V, 1 V, 400 mV and 200mv p-p dependant upon bits D10 and D9 of the control register as explained earlier (See Control register, system Architecture for more details). The response signal can be subsequently amplified by a factor of x1 or x5 dependant upon the state of bit D8 of the control register. The output excitation voltage setting and Pre-ADC gain should be chose such that the largest signal is presented to the ADC input whilst ensuring that the Gain factor dose not vary significantly as outlined in the last paragraph.

There fore in order to calibrate the AD5933 the user must know in what impedance range ($\pm 10K\Omega$) the unknown impedance connected between Vout and Vin lies. The user subsequently is required to choose a known measured calibration impedance e.g. 1% precision resistor, which lies in the middle of this user determined impedance range. This calibration resistor is chose such that the ratio of $Rfb / Z_{cal-mid}$ lies within the range of (0.2, 0.1, 0.066). The upper limit of Rfb within the unknown

impedance range therefore should be no more than $Z_{cal-mid} \times 0.2$ and no less than $(Z_{cal-mid} \times 0.066)$. The output voltage excitation levels and pre-ADC settings are then chosen such that the largest signal is then presented to the ADC input ($\approx 2vp-p$) by choosing an output excitation voltage of $2vp-p$ and a pre-ADC gain of 5. A sample matrix of such system settings is shown in Table 9 for a variation of chosen impedance values.

Table 9. AD5933 System Conditions

Impedance Range (Ω)	Rfb Value (Ω)	Output Excitation/ Pre-ADC Settings	Chosen Impedance Values	Rfb/ Z_unknown Ratio
5k to 15k	1k	2vp-p, x5	5k, 10k, 15k	0.2, 0.1, 0.066
50k to 150k	10k	2vp-p, x5	50k, 100k, 150k	0.2, 0.1, 0.066
500k to 1.5M	100k	2vp-p, x5	500k, 1M, 1.5M	0.2, 0.1, 0.066
1M to 3M	200k	2vp-p, x5	1M, 2M, 3M	0.2, 0.1, 0.066

Example: Taking the case where the unknown impedance connected between V_{out} and V_{in} of the AD5933 is known to lie between $50k\Omega$ and $150k\Omega$ impedance range and the user would like to analyze the unknown impedance profile of the network under test within the 10 kHz to 120K Hz frequency range. The user will then choose a calibration impedance which lies in the middle of this impedance range, i.e., $100k\Omega$. The user must then choose a value of feedback resistor so suit the impedance range and ensure the gain factor variation within this known impedance range is limited to lie within $(0.2 < 0.1 < 0.066)$. Therefore a $1k\Omega$ resistor is chosen by the user.

In order to ensure that the gain factor did not in fact vary over the impedance range for the chosen value of feedback resistance the user takes a known impedance value from the start middle and end of the impedance range e.g. $50k\Omega$, $100k\Omega$ and $150k\Omega$. The user calibrates the system using each of the sample impedances in turn, at a mid frequency point of interest i.e. 60 kHz and at a mid point temperature of interest e.g. $25^\circ C$. In each case the user selects the output excitation voltage to be $2vp-p$ and the pre-ADC gain value to be x5 to get the largest signal to the ADC over the impedance range. The digital code returned at each point in the frequency range of interest (10 kHz-120 kHz) was then used to calculate a Gain factor. The variation in the gain factor versus frequency is shown below in Figure 46.

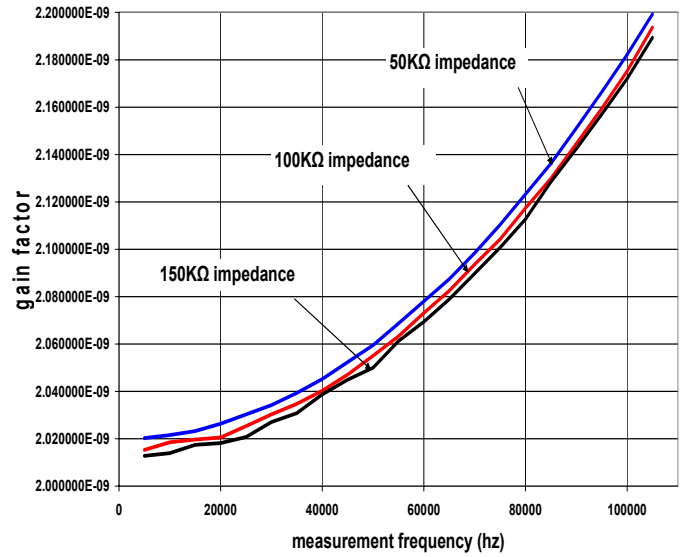

Figure 46. Calibrated Gain Factor vs. Sweep Frequency for a Feedback Resistor of 10 kΩ over Unknown Impedance Range

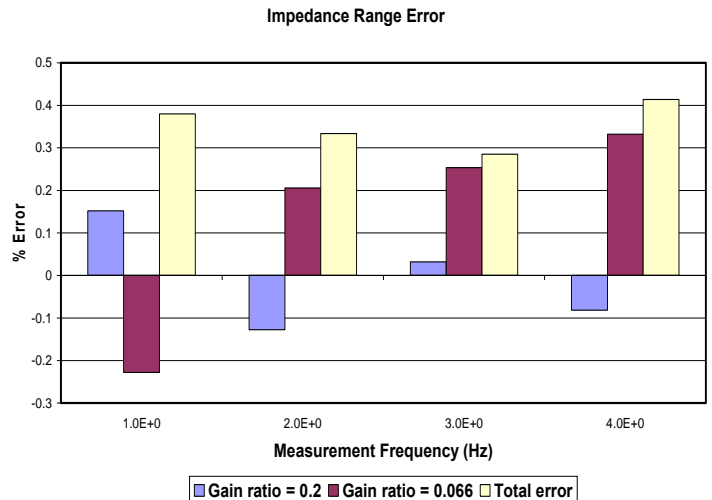

Figure 47. Impedance Range Error

Figure 47 shows the impedance range % error versus frequency from a known calibration impedance of $100k\Omega$ calibrated at 60 kHz. The plot shows that the % error is $< 1\%$ - with the smallest error being returned at the calibration frequency in accordance with the gain factor theory. The plot also shows, as a result of the reducing the gain factor variation over the impedance range, the variation in the error returned by the AD5933 over frequency is subsequently reduced to $< 0.2\%$.

Summary of calibration steps

- The user must establish in what range the impedance under analysis lies and what frequency range the impedance needs to be analyzed over.
- Choose a calibration impedance value in the middle of this impedance range. Having established the limits of the impedance range choose the feedback resistor such that the ratio of the feedback resistor to the impedance limits to be in the range (0.2, 0.2, and 0.0066). This will ensure the gain factor variation over the impedance range will be small thus reducing the error returned by the AD5933.
- Choose the calibration frequency to be at a mid frequency point of interest and the device temperature to lie in the mid temperature range of interest.
- Choose the output excitation voltages and pre ADC gain value such that the signal presented to the ADC is as large as possible whilst ensuring the gain factor variation with respect to the impedance range is small as outlined above. By limiting the sweep frequency range you will be minimising the linear "frequency error" associated with the gain factor. I.e. try and limit the sweep frequency to be small as possible around the unknown impedance value.
- In order to reduce the error further the user may carry out a two point calibration

PERFORMING A FREQUENCY SWEEP—FLOW CHART

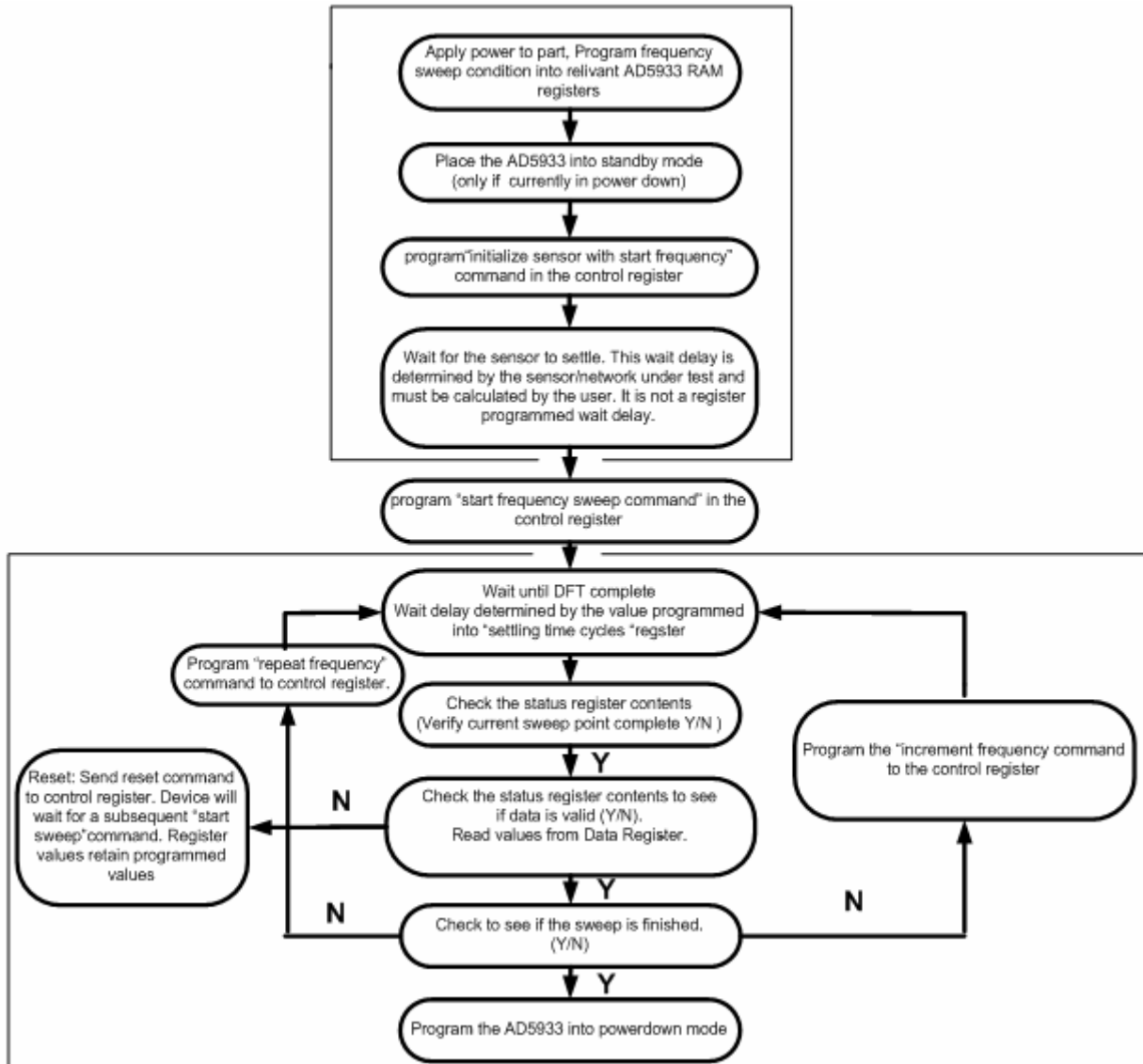

Figure 48. Frequency Sweep Flow Diagram

REGISTER MAP (EACH ROW EQUALS 8 BITS OF DATA)

Table 10.

RAM					
Control Register	80h	D15-D8	Read/Write	RAM	Bit
	81h	D7-D0	Read/Write	RAM	Bit
<p>Comment: The control register is a 16 bit register that sets the AD5933 control modes. The four MSBs of the control register are decoded to provide control functions such as performing a frequency sweep, powering down the part and various other control functions defined in register control map . For example to take a temperature measurement the user would write 90 hex (1001 0000) to reg location 80 hex with a single byte write.</p> <p>The user may choose to only write to reg location 80 hex and not to alter the contents of 81 hex. Note: The control register should NOT be written to as part of a Block Write command. The control register allows the user to also program the excitation voltage and set the system clock (external clock, pll or crystal oscillator). Note a reset command to the control register will not reset any programmed values associated with the sweep (i.e. start frequency, no of increments, frequency step). However the reset will result in the index counter of frequency increments (90/91 hex) being reset to all zeros. Note after a reset command an Initialize Sensor command must be issued to restart the frequency sweep sequence (see Figure 48).</p> <p>Default value upon reset: D15 – D0 will reset to A0 00H upon power up</p>					
Start Frequency (24 Bits)	82h	D23-D16	Read/Write	RAM	
	83h	D15-D8	Read/Write	RAM	
	84h	D7-D0	Read/Write	RAM	
<p>Comment: The Start Frequency register contains the 24 bit digital representation of the frequency from where the subsequent frequency sweep will be initiated. For example if the user requires the sweep to start from frequency 28kHz (using a 16.777 MHz clock) then the user programs 0D hex to reg location 82h, AC hex to reg location 83h and 0B hex to reg location 84h. This will ensure the output frequency will start at 28kHz.</p> <p>The formula for calculating the code required for a desired Start Frequency is given by the following:</p> $\text{Start Frequency code} = (\text{Required Start Frequency} / (\text{MCLK}/4)) * 2^{27}$ <p>Default value upon reset: D23-D0 is not reset on power up. After a reset command the contents of this register is not reset and thus maintains its previous contents.</p>					
Frequency Increment Word	85h	D23-D16	Read/Write	RAM	
	86h	D15-D8	Read/Write	RAM	
	87h	D7-D0	Read/Write	RAM	
<p>Comment: The Frequency Increment register contains a 24 bit representation of the frequency increment between consecutive frequency points along the sweep. For example if the user requires an increment step of 10 Hz using a 16.777 MHz clock, the user should program 00 hex to reg location 85h, 01 hex to reg location 86h and 64 hex to reg location 87h.</p> <p>The formula for calculating the Increment Frequency is given by the following :</p> $\text{Increment Frequency code} = (\text{Required Increment Frequency} / (\text{MCLK}/4)) * 2^{27}$ <p>Default value upon reset: D23-D0 is not reset on power up. After a reset command the contents of this register is not reset and thus maintains its previous contents.</p>					
No of Increments (9 Bits) Bits D15-D9 = Don't care Bits D8-D0 = Number of Frequency Increments.	88h	D15-D8	Read/Write	RAM	Integer number stored in binary format
	89h	D7-D0	Read/Write	RAM	
<p>Comment: This register determines the number of frequency points in the frequency sweep. The number of points is represented by a 9 bit word, D8 to D0. D9 to D15 are Don't Care bits. This register in conjunction with the Start Frequency and Increment Frequency registers determine the frequency sweep range for the sweep operation. The maximum number of increments which can be programmed is 511.</p> <p>Default value upon reset: D8-D0 is not reset on power up. After a reset command the contents of this register is not reset and thus maintains its previous contents.</p>					

Settling Time Cycles D15-D11 = Don't care D10-D9 = 2 Bit Decode D8-D0 = Number Cycles D10 D9 0 0 Default 0 1 Number Cycles * 2 1 0 Reserved 1 1 Number Cycles * 4	8Ah	D15-D8	Read/Write	RAM	Integer number stored in binary format
	8Bh	D7-D0	Read/Write	RAM	

Comment: This register determines the number of output excitation cycles which are allowed to pass through the sensor, after receipt of a Start, Increment or Repeat Frequency command, before the ADC is triggered to perform a conversion of the response signal. The "Settling Time Cycles" register value essentially determines the delay between a frequency Start/Increment/Repeat command and the time an ADC conversion commences. The number of cycles is represented by a 9 bit word, D8 –D0. The value programmed into the "Settling Time Cycles" register can be increased by a factor of 2 or 4 depending upon the status of bits D10 – D9. The five most significant bits D15-D11 are Don't Care bits. The max number of output cycles that can be programmed is $511 * 4 = 2044$ cycles. For example, consider an excitation signal of 30 KHZ, the max delay between the programming of this frequency and the time that this signal is first sampled by the ADC is $\approx 511 * 4 * 33.33 \text{ us} = 68.126 \text{ ms}$. 1024 samples are taken by the ADC and the result is stored as Real and Imaginary data in registers 94h to 97h. The conversion process takes approximately 1mS using a 16.777 MHz clock.

Default value upon reset: D10-D0 is not reset on power up. After a reset command the contents of this register is not reset and thus maintains its previous contents.

Leakage Limit for Test A D7-D4 = Don't care D3-D0 = 4 Bit Limit.	8Ch	D7-D0	Read/Write	RAM	4 bit Threshold code
Leakage Limit for Test B D7-D4 = Don't care D3-D0 = 4 Bit Limit.	8Dh	D7-D0	Read/Write	RAM	
Leakage Limit for Test C D7-D4 = Don't care D3-D0 = 4 Bit Limit.	8Eh	D7-D0	Read/Write	RAM	

Comment: These three registers contain a digital representation of the Pass/Fail limits for leakage mode tests A, B & C. The leakage limits are represented by a 4 bit word, D3-D0 in each of the registers. The user can modify the Pass/Fail limits by writing to these 4 bits.

Test A measures the leakage current across the output and input terminals, VOUT and VIN. The four bits D3-D0 at reg 8C hex sets an internal comparator threshold value which determines the user pass/fail limit on the leakage that flows between VOUT and VIN.

Default value upon reset: D3-D0 defaults to 4 hex on power-up. This corresponds to a leakage limit of $\approx 1 \text{ ua}$. After a reset command the contents of this register is not reset and thus maintains its previous contents.

Test B measures the leakage current between VOUT and Gnd. The four bits D3-D0 at register 8D hex sets an internal comparator threshold value which determines the user programmable pass/fail limit on the leakage that flows between VOUT and Gnd

Default value upon reset: D3-D0 will default to 7 hex on power-up. This corresponds to a leakage limit of $\approx 1 \text{ ua}$. After a reset command the contents of this register is not reset and thus maintains its previous contents.

Test C measures the leakage current between VIN and Gnd. The four bits D3-D0 at register 8E hex sets an internal comparator threshold value which determines the user programmable pass/fail limit on the leakage that flows between VIN and Gnd.

Default value upon reset: D3-D0 will default to 4 hex on power-up. This corresponds to a leakage limit of $\approx 1 \text{ ua}$.

After a reset command the contents of this register is not reset and thus maintains its previous contents.

Status Register	8F h	D7-D0	Read Only	RAM	Bits
-----------------	------	-------	-----------	-----	------

Comment: The Status Register is used to confirm that particular measurement tests have been successfully completed. Each of the bits from D7 –D0 indicates the status of specific functionality of the AD5933.

The status of bit D0 indicates the status of a Measure Temperature instruction. It is set to 1 when a valid temperature measurement has been carried out by the part. This indicates that valid data is available for reading at the temperature data location 92 hex and 93 hex. This bit is reset on receipt of a Measure Temperature command. This bit is reset on power-up.

The status of bit D1 indicates the status of a frequency point impedance measurement. This bit is SET when the AD5933 has completed the current frequency point impedance measurement. This indicates that there is valid Real and Imaginary data in registers 93-97 hex. This bit is reset on receipt of a Start, Increment, or Repeat Frequency command. This bit is reset on power-up and also on the receipt of a reset command.

The status of bit D2 indicates the status of the programmed frequency sweep. This bit is set when all programmed increments to the Number of Increments register, is complete. This bit is reset on power-up and on receipt of a reset command. Bits D3-D6 indicate the status of leakage tests A,B & C. D3 when set indicates that all leakage tests are complete. Bits D4-D6 indicates the status of each test, pass, or fail. The bit is set if the test has passed and is reset if the test has failed. (1 = pass; 0 = fail). Bit D3 is reset on receipt of a Run Leakage Test command. Bit D3 is also reset on power-up and on receipt of a reset command. Bits D4-D6 is not reset on power-up or on receipt of a reset command. Unless Bit D3 is set indicating completion of leakage test, bits D4-D6 are not valid.

The status of bit D7 indicates the program status of the OTP Master fuse. If the Master fuse has been programmed, D7 will be set. If not programmed, D7 will be 0. If the Master fuse is programmed, further writes to the OTP memory is not allowed. The status of this bit on power-up or on receipt of a reset command reflects the status of the Master fuse.

Index Counter of Frequency increments. (9 Bits) Bits D15-D9 = Don't care Bits D8-D0 = Increments register after a frequency increment command.	90h	D15-D8	Read Only	RAM	Integer number stored in binary format
	91h	D7-D0	Read Only	RAM	

Comment: This register is an Index counter for the frequency increments performed during a frequency sweep. It allows the user track their position in the sweep. The index is stored as a 9 bit binary number in bits D8-D0. Bits D15-D9 are Don't Care bits. The maximum integer number that this register will count to is a number equal to the number of increments programmed to the Number of Increments register, registers 88/89h. D8-D0 are reset to zero at the start of a frequency sweep and increments for each subsequent frequency step.

Default value upon reset: D8-D0 are reset on power-up. D8-D0 not reset on receipt of a reset command.

Temperature Data Register	92h	D15-D8	Read Only	RAM	Temperature (°C) twos complement data format.
	93h	D7-D0	Read Only	RAM	

Comment. The Temperature Data Register is a 16-bit read-only register which stores the result from the internal temperature sensor conversion, in 14-bit twos complement format. D13 is the sign bit and indicates whether the temperature is positive or negative . D13=1 indicates the temperature is negative and the user should follow the appropriate conversion formula below., D13 =0 indicates the temperature is positive and again the user should follow the appropriate conversion formula. D14 and D15 are Don't Care bits.

1. Positive Temperature code= ADC Code(decimal)/32
2. Negative Temperature code = (ADC Code(decimal) – 16384)/32 *

*Use all 14 bits of the data byte, including the sign bit.

Default value on reset: This register is not reset on power-up or on receipt of a reset command. Note the values of D13-D0 are not valid unless D0 in the status register is set, indicating a Measure Temperature instruction is complete.

Real Data	94h	D15-D8	Read Only	RAM	Twos complements data
	95h	D7-D0	Read Only	RAM	
Imaginary Data	96h	D15-D8	Read Only	RAM	
	97h	D7-D0	Read Only	RAM	

Comment: These registers contain a digital representation of the Real and Imaginary components of the impedance measured for the current frequency point. The values are stored in 16 bit twos complement format. To convert this number to an actual impedance value, the magnitude i.e. $\sqrt{(\text{real}^2 + \text{imaginary}^2)}$ must be multiplied by an Admittance/code number (called a Gain Factor) to give the admittance and the result inverted to give impedance. The Gain Factor will vary for each AC excitation voltage / Gain combination. A Gain Factor value for the recommended Oil, Air & Vacuum excitation voltage / Gain combination will be stored in OTP at locations 60h to 6Bh

Example

Measurement of Resonant circuit in air. Assume the values of Gain Factor stored in OTP at location 60 h to 6B h are as follows:

- Oil: Gain Factor = 112.984e-12; Memory Location: 60h-63h
- Functional (Air): Gain Factor = 225.943e-12; Memory Location: 64h-67h
- Vacuum: Gain Factor = 2.9250e-9; Memory Location: 68h-6Bh

The system is set up with an AC excitation voltage of 1Vp-p and a post gain value of x5 as the recommended setup for measurement in Air. Assume the results in the Real and Imaginary registers are as follows at a frequency point.

Real register: = 038B hex = 907 decimal; Imaginary register : = 0204 hex = 516 decimal.

$$\text{Magnitude} = \sqrt{(907^2 + 516^2)} = 1043.506$$

$$\text{Gain factor} = 225.943\text{e-}12$$

$$\text{Admittance} = \text{Magnitude} * \text{Gain factor} = 2.3577\text{e-}7$$

$$\text{Impedance} = 1/\text{Admittance} = 4.241369 \text{ M}\Omega$$

Default value upon reset: These registers are not reset on power-up or on receipt of a reset command. Note that the data in these registers is only valid if bit D1 in the Status register is set indicating that the processing at the current frequency point is complete.

CONTROL REGISTER

The AD5933 contains a 16 bit control register (address 80h and 81h) that set the AD5933 control modes. The five MSBs of the control register are decoded to provide control functions for frequency sweep, power down and various other control functions, defined in Table below. The other command functions of the control register are explained on the following pages.

Note that for error checking on the control register it is advised to write one byte at a time with PEC enabled. This allows full error checking to be completed before the control register is updated and therefore ensures the control is not updated with incorrect data. The Control register will power-up in the following state xA000h (i.e., in Power-down)

Table 11. Control Register Map

Bit						
D15		D15	D14	D13	D12	Frequency Sweep
D14		0	0	0	0	No Operation/Exit Fuse Blow Mode
D13		0	0	0	1	Initialize Sensor with Start Frequency
D12		0	0	1	0	Start Frequency Sweep
		0	0	1	1	Increment Frequency
		0	1	0	0	Repeat Frequency
		1	0	0	0	Enter Fuse Blow Mode
		1	0	0	1	Measure Temperature
		1	0	1	0	Power Down
		1	0	1	1	Standby Mode
		1	1	0	0	Run Leakage Mode Tests A, B, & C.
		1	1	0	1	External Cal Mode
D11						Enable External Out Pin, Default = 0; Cal Mode = 1.
D10			D10	D9		Output Voltage
D9			0	0		No Divide. (Normal Mode = 2.0V)
			0	1		Divide by 10 (200mv)
			1	0		Divide by 5 (400mv)
			1	1		Divide by 2 (1.0v)
D8						Post Gain "0" = Gain X 5; "1" = Gain X 1.
D7						Reserved. Set to Zero.
D6						Reserved. Set to Zero.
D5						Reserved. Set to Zero.
D4						Reset
D3			D3	D2		System Clock
D2			0	0		Internal Oscillator
			0	1		Reserved.
			1	0		External Oscillator
			1	1		Reserved
D1						Reserved. Set to Zero.
D0						Reserved. Set to Zero.

CONTROL REGISTER DECODE

Initialize Sensor with Start Frequency

This command enables the DDS to output the start frequency for an indefinite time. It is used to excite the sensor initially. When the output load (sensor) has settled after a time determined by the user, the user must initiate a “Start Frequency Sweep” command to begin the frequency sweep

Start Frequency Sweep

This command starts the frequency sweep routine. When the AD5933 receives this command, it starts counting a delay cycle that will gate the ADC conversion pulse. This delay cycle has already been preprogrammed as number of output settling cycles by the user.

Increment Frequency

The “Increment Frequency” command is used to step to the next frequency point in the sweep. This usually happens after data from the previous step has been transferred and verified by the DSP. When the AD5933 receives this command, it waits for the programmed number of Settling Time cycles before commencing the ADC conversion process.

Repeat Frequency

Repeat frequency allows the user to repeat any given frequency if the data gets corrupted or the measurement sequence doesn't complete. When the AD5933 receives this command, it waits for the programmed number of Settling Time cycles before commencing the ADC conversion process.

Power Down

Power Down powers down all the blocks in the chip except the interface. All amplifiers and the oscillator will be powered off. The default on power-up of the AD5933 is power down and the control register will contain the code 1010000000000000 (A000h). In this mode both the output and input pins Vout and Vin will be tied to GND.

Standby Mode

Powers the part up for general operation; all the amplifiers will be powered up but their outputs will be tied to GND. The internal oscillator will also be powered up and running.

Measure Temperature

This initiates a temperature reading from the part. The part does not need to be in Power Up mode to perform a temperature reading. The block will power itself up, take the reading, and then power down again. When complete, D0 in the Status Register is set indicating valid data in the Temperature Data registers (D15-D8).

Enter Fuse Blow Mode

This bit needs to be set to enter Fuse blow mode. In this mode the user can write to One Time Programmable OTP memory.

Error Checking

Set bit in Control Register to enable this. Enable = 1; disable = 0.

Reset

A Reset command refreshes all Memory, resets the ADC, and sets VOUT output to Vdd/2 dc. Register contents are not overwritten. An Initialize Sensor command is required to restart the frequency sweep command sequence.

System Clock

Allows the user to configure either the internal oscillator, or an external reference clock or to allow an internal PLL to provide a clock for the system.

Output Voltage

This allows the user to program the AC excitation voltage levels at VOUT. The AC excitation voltages available are 2V P-T-P, 1V P-T-P, 400mV P-T-P and 200mV P-T-P.

Post Gain

This allows the user to amplify the response signal by a multiplication factor of x5 or x1 into the ADC if required.

Leakage Mode Tests

Runs the sequence of leakage mode tests A, B, and C. When complete bit D3 in the Status register is set indicating the status of bits D4-D6 is valid. The status of bits D4-D6 in the Status Register indicate whether the test has passed (Bit=1) or failed (Bit=0). Note that unless bit D3 is set, the status of bits D4 to D6 is not valid. The pass/fail leakage limits are set using D0-D3 of registers 8Ch to 8Eh in the register map. On power-up these values equate to a 1uA leakage limit. The user can modify the register contents to change the leakage limits by writing to these 4 bits. Bit D3 is reset on power-up and on receipt of a Reset command. Bits D4 to D6 are not reset on power-up.

Leakage Mode A:

Measures leakage between VOUT and VIN. Pass/Fail limits default to 1ua on power-up.

Leakage Mode B:

Measures leakage between VOUT and GND. Pass/Fail limits default to 1ua on power-up.

Leakage Mode C:

Measures leakage between VIN and GND. Pass/Fail limit defaults to 1ua on power-up.

External Cal Mode:

Enables the AD5933 for external calibration. In this mode, the EXT_CLK pin is connected directly to VOUT, bypassing the DDS block. The output of the first I-V amplifier in the receive (VIN) path is also switched directly to the EXT_OUT pin. On power-up this bit resets to “0”, configuring the part for normal mode of operation.

STATUS REGISTER:

The status register indicates the status of the various measurement tests which have been programmed to the part.

Table 12. Status Register

Status Register Address	Control Word	Function
8Fh	0000 0001	Valid Temperature Reading
8Fh	0000 0010	Valid Real/Imaginary Data
8Fh	0000 0100	Frequency Sweep Complete
8Fh	0000 1000	Leakage Tests Complete
8Fh	0001 0000	Leakage Test A Pass
8Fh	0010 0000	Leakage Test B Pass
8Fh	0100 0000	Leakage Test C Pass
8Fh	1000 0000	Master Fuse Programmed

Valid Temperature Reading Bit

Set (=1) when the temperature sensor signals the end of conversion (temperature data available for reading). Will be reset to 0 when a temperature reading command is issued.

Valid Real/Imaginary Data

Set (=1) when the processing of data for the current frequency point is finished indicating real/imaginary data available for reading. Reset when one of DDS Start/Increment/Repeat commands are issued. This bit is reset to 0 when a reset command is issued to Control Register.

Frequency Sweep Complete

Set when the processing of data for last frequency point in the sweep is finished. Reset when a Start Frequency Sweep command is issued. Will be reset when a reset command is issued to the Control Register.

Leakage Test Complete

Set when the leakage test sequence is finished. Reset when a leakage test command is issued. Will be reset when a reset command is issued to Control Register.

Leakage Test Pass/Fail

Confirms whether the leakage test has passed to the leakage limits set in the register map. (Set when test has passed, reset when test has failed test. The result is only valid if bit D3 is set.)

Master Fuse Blown

Set when Master Fuse is programmed.

SERIAL BUS INTERFACE

Control of the AD5933 is carried out via the I²C Serial Interface Protocol. The AD5933 is connected to this bus as a slave device, under the control of a master device. The AD5933 has a 7-bit serial bus slave address. When the device is powered up, it will do so with a default serial bus address; 0001101

GENERAL I²C TIMING

The diagram below shows the timing diagram for general read and write operations using the I²C interface. The general I²C protocol operates as follows:

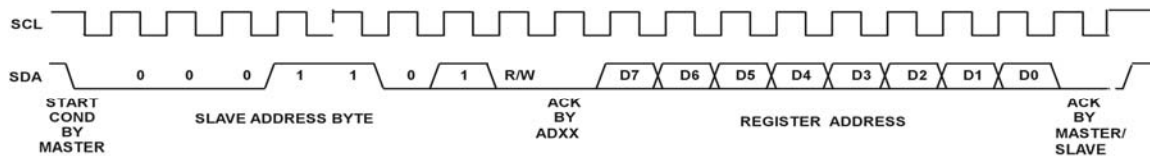

Figure 49.

1. The master initiates data transfer by establishing a START condition, defined as a high to low transition on the serial data line SDA while the serial clock line SCL remains high. This indicates that a data stream will follow. The slave responds to the START condition and shifts in the next 8 bits, consisting of a 7-bit slave address (MSB first) plus an R/W bit, which determines the direction of the data transfer, i.e. whether data will be written to or read from the slave device (0 = write, 1 = read).

The slave responds by pulling the data line low during the low period before the ninth clock pulse, known as the acknowledge bit, and holding it low during the high period of this clock pulse. All other devices on the bus now remain idle while the selected device waits for data to be read from or written to it. If the R/W bit is a 0, then the master will write to the slave device. If the R/W bit is a 1, the master will read from the slave device.
2. Data is sent over the serial bus in sequences of nine clock pulses, 8 bits of data followed by an acknowledge bit, which can be from the master or slave device. Data transitions on the data line must occur during the low period of the clock signal and remain stable during the high period, as a low to high transition when the clock is high may be interpreted as a STOP signal. If the operation is a write operation, the first data byte after the slave address is a command byte. This tells the slave device what to expect next. It may be an instruction telling the slave device to expect a block write, or it may simply be a register address that tells the slave where subsequent data is to be written. Since data can flow in only one direction as defined by the R/W bit, it is not possible to send a command to a slave device during a read operation. Before doing a read operation, it may first be necessary to do a write operation to tell the slave what sort of read operation to expect and/or the address from which data is to be read.
3. When all data bytes have been read or written, stop conditions are established. In WRITE mode, the master will pull the data line high during the 10th clock pulse to assert a STOP condition. In READ mode, the master device will release the SDA line during the low period before the 9th clock pulse, but the slave device will not pull it low. This is known as No Acknowledge. The master will then take the data line low during the low period before the 10th clock pulse, then high during the 10th clock pulse to assert a STOP condition.

WRITING/READING TO THE AD5933

The interface specification defines several different protocols for different types of read and write operations. The ones used in the AD5933 are discussed below. The following abbreviations are used:

- S - Start
- P - Stop
- R - Read
- W - Write
- A - Acknowledge
- \overline{A} - No Acknowledge

Write Byte/Command Byte

In this operation the master device sends a byte of data to the slave device. The write byte can either be a data byte write to a RAM location or can be a command operation.

1. To write data to a register the command sequence is as follows:
2. The master device asserts a start condition on SDA.
3. The master sends the 7-bit slave address followed by the write bit (low).
4. The addressed slave device asserts ACK on SDA.
5. The master sends a register address.
6. The slave asserts ACK on SDA.
7. The master sends a data byte.
8. The slave asserts ACK on SDA.
9. The master asserts a STOP condition on SDA to end the transaction.



Figure 50. Writing Register Data to Register Address

In the AD5933, the write byte protocol is also used to set a pointer to a register location. This is used for a subsequent single byte read from the same address or block read or write starting at that address. This is done as follows:

1. To set a register pointer the following sequence is applied:
2. The master device asserts a start condition on SDA.
3. The master sends the 7-bit slave address followed by the write bit (low).
4. The addressed slave device asserts ACK on SDA.
5. The master sends a command code (pointer command 1011 0000).
6. The slave asserts ACK on SDA.
7. The master sends a data byte (register location pointer is to point to).
8. The slave asserts ACK on SDA.
9. The master asserts a STOP condition on SDA to end the transaction.

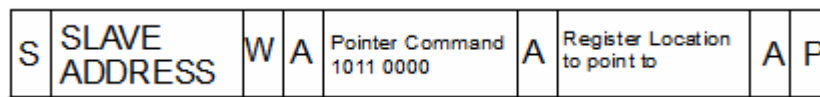

Figure 51. Setting Pointer to Register Address

BLOCK WRITE

In this operation, the master device writes a block of data to a slave device. The start address for a block write must previously have been set. In the case of the AD5933 this is done by setting a pointer to set the RAM/OTP address.

1. The master device asserts a start condition on SDA.
2. The master sends the 7-bit slave address followed by the write bit (low).
3. The addressed slave device asserts ACK on SDA.
4. The master sends An 8 bit command code (10100000) that tells the slave device to expect a block write.

5. The slave asserts ACK on SDA.
6. The master sends a data byte that tells the slave device the number of data bytes will be sent to it.
7. The slave asserts ACK on SDA.
8. The master sends the data bytes.
9. The slave asserts ACK on SDA after each data byte.
10. The master asserts a STOP condition on SDA to end the transaction.

These command codes are used for reading/writing to the interface and the memory. They are further explained in the appropriate sections but are grouped here for ease of reference.

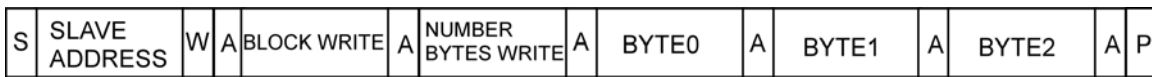

Figure 52. Writing a Block Write

AD5933 READ OPERATIONS

The AD5933 uses the following I²C read protocols:

Receive Byte

In this operation, the master device receives a single byte from a slave device as follows:

1. The master device asserts a START condition on SDA.
2. The master sends the 7-bit slave address followed by the read bit (high).
3. The addressed slave device asserts ACK on SDA.
4. The master receives a data byte.
5. The master asserts NO ACK on SDA. (Slave needs to check that master has received Data)
6. The master asserts a STOP condition on SDA and the transaction ends.

In the AD5933, the receive byte protocol is used to read a single byte of data from a RAM or OTP memory location whose address has previously been setting the address pointer.



Figure 53. Reading Register Data

Block Read

In this operation, the master device reads a block of data from a slave device. The start address for a block read must previously have been set. This is again done by setting a pointer to set the RAM/OTP address.

1. The master device asserts a START condition on SDA.
2. The master sends the 7-bit slave address followed by the write bit (low).
3. The addressed slave device asserts ACK on SDA.
4. The master sends a command code (10100001) that tells the slave device to expect a block read.
5. The slave asserts ACK on SDA.
6. The master sends a byte count data byte that tells the slave how many data bytes to expect.
7. The master asserts ACK on SDA.
8. The master asserts a repeat start condition on SDA. (This is required to set Read bit high)
9. The master sends the 7-bit slave address followed by the read bit (high).
10. The slave asserts ACK on SDA.
11. The master receives the data bytes.
12. The master asserts ACK on SDA after each data byte.
13. A NACK is generated after the last byte to signal the end of the read.
14. The master asserts a STOP condition on SDA to end the transaction.

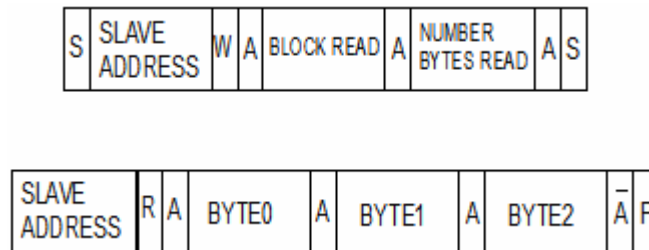

Figure 54. Performing a block read

ERROR CORRECTION**PEC**

The AD5933 provides the option of issuing a PEC (Packet Error Correction) byte after all commands. This enables the user to verify that the data received by or sent from the AD5933 is correct. The PEC byte is an optional byte sent after that last data byte has been written to or read from the AD5933. The protocol is as follows:

1. The AD5933 issues a PEC byte to the master. The master should check the PEC byte and issue another block read if the PEC byte is incorrect.
2. A NACK is generated after the PEC byte to signal the end of the read.
3. The PEC is generated per the following specifications.

Note: The PEC byte is calculated using CRC-8. The Frame Check Sequence (FCS) conforms to CRC-8 by the polynomial:

$$C(x) = x^8 + x^2 + x^1 + 1$$

CHECKSUM

A checksum register is available to allow the user to verify the correct contents of the frequency register, frequency increment register, and number of increments. The checksum register is based on an error checking algorithm from the above registers. The user reads this checksum register and verifies contents are correct.

USER COMMAND CODES

These command codes are used for reading/writing to the interface and the memory. They are further explained in the appropriate sections but are grouped here for ease of reference.

Table 13.

Command Code	Code Name	Code Description
1010 0000	Block Write	This command is used when writing multiple bytes to the RAM. See block write section for further explanations.
1010 0001	Block Read	This command is used when reading multiple bytes from the RAM/Memory. See block write section for further explanations.
1011 0000	Address Pointer	This command enables the user to set the address pointer to any location in the memory. The data will contain the address register of the register the pointer should be pointing to.

WRITING TO MEMORY: STORING CALIBRATION VARIABLES.**Fuse Blowing**

The command flow for blowing Fuse registers is as follows:

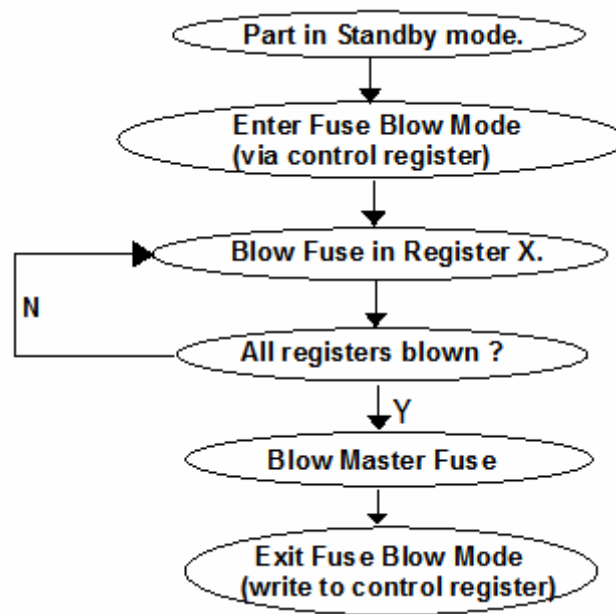

Figure 55.

Data is stored in memory by writing it to a register address and then blowing fuses to store that code into the memory. To blow the fuses the part first must be put into Fuse blow mode. This is set by enabling the “Enter fuse blow Mode” command in the Control Register. This requires V_{dd} pin to be temporarily put to 6.5v and the following timing configuration as shown below. In this mode SCL pin must be pulsed to provide an internal signal to blow the fuses.

The command sequence is as follows:

1. The master device asserts a START condition on SDA.
2. The master sends the 7-bit slave address followed by the write bit (low).
3. The addressed slave device asserts ACK on SDA.
4. The master sends a command code (1010 0010) that tells the slave device to perform a NORMAL fuse blow.
5. The slave asserts ACK on SDA.
6. The master sends the memory address to blow.
7. The slave asserts ACK on SDA.
8. The master sends the data to be blown into the memory address.
9. The slave asserts ACK on SDA.
10. The master asserts a STOP condition.
11. The VDD and SCL pin can now be driven high following the timing conditions in the timing diagram. SCL needs to be held high for 1 ms for valid fuse blow.

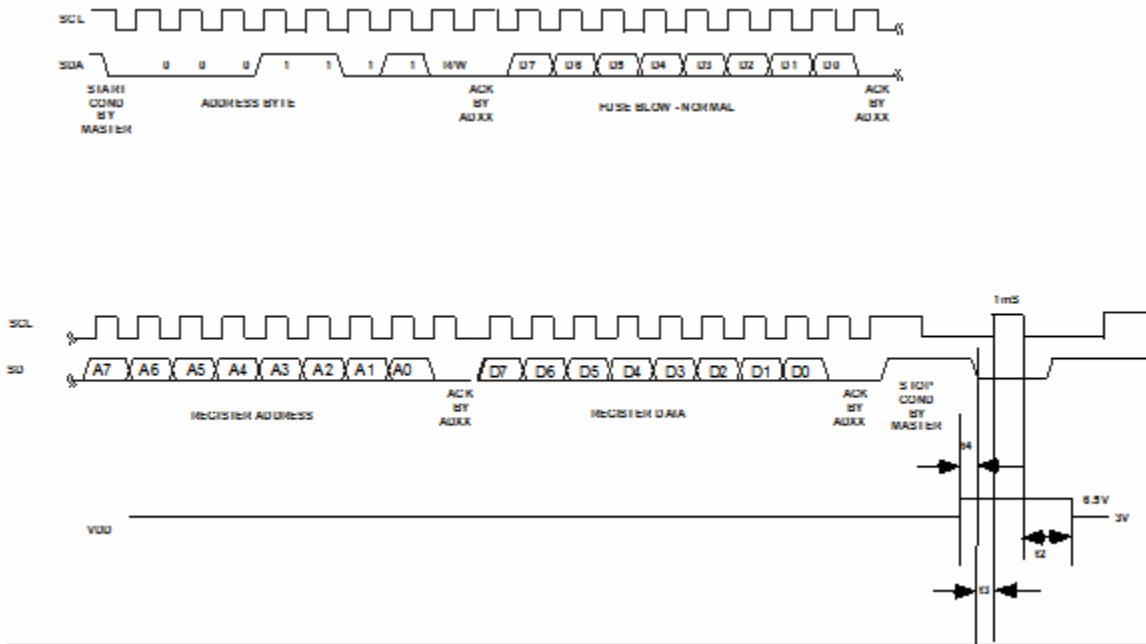

Figure 56.

When the all the memory locations has been programmed and blown a master fuse should be blown to ensure that the memory is fully locked. This only needs to be done once to the master fuse register. The timing sequence is the same as for normal fuse blow mode, as follows:

1. The master device asserts a START condition on SDA.
2. The master sends the 7-bit slave address followed by the write bit (low).
3. The addressed slave device asserts ACK on SDA.
4. The master sends a command code (1010 0011) that tells the slave device to perform a MASTER fuse blow.
5. The slave asserts ACK on SDA.
6. The master sends a no-op. (0000 0000)
7. The slave asserts ACK on SDA.
8. The master asserts a STOP condition.
9. The VDD and SCL pin can now be driven high following the timing conditions in the timing diagram. SCL needs to be held high for 1mS for valid fuse blow.

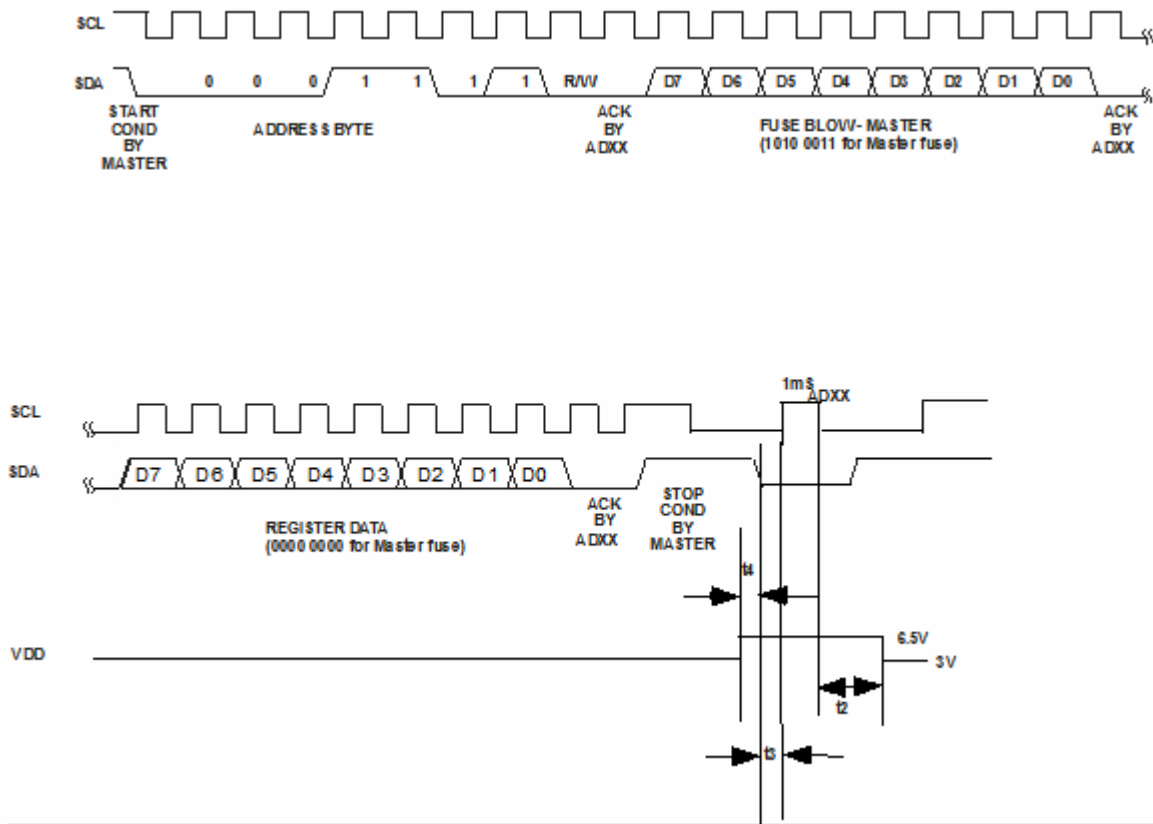

Figure 57.

Note: Register address and data for the Master Fuse Blow Mode is 00h.

To Exit Fuse Blow Mode the user writes a command to the control register. See section on control register.

OUTLINE DIMENSIONS

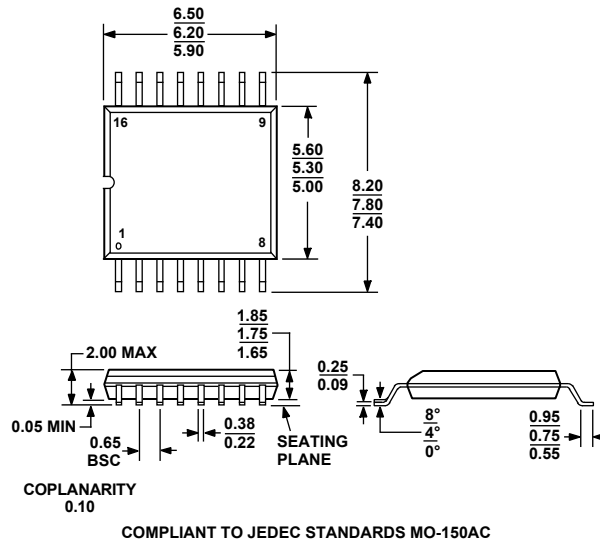

Figure 58. 16-Lead Shrink Small Outline Package [SSOP] (RS-16)
 Dimensions shown in millimeters

ORDERING GUIDE

Model	Temperature Range	Package Description	Package Option
EVAL AD5933-U1	-40°C to +125°C	16-Lead Shrink Small Outline Package SSOP Evaluation board	RS
EVAL AD5934-U1	-40°C to +125°C	16-Lead Shrink Small Outline Package SSOP Evaluation board	RS
AD5933BRSZ-U1 ¹	-40°C to +125°C	16-Lead Shrink Small Outline Package SSOP	RS
AD5934BRSZ-U1 ¹	-40°C to +125°C	16-Lead Shrink Small Outline Package SSOP	RS

¹ Z = Pb-free part.

NOTES

NOTES

NOTES